



S-Series VoIP PBX Administrator Guide



Sales Tel: +86-592-5503309
E-mail: sales@yeastar.com
Support Tel: +86-592-5503301
E-mail: support@yeastar.com
Web: <http://www.yeastar.com>

Version: 30.0.0.32
Revised: 2016.07.19

Copyright

Copyright 2006-2016 Yeastar Information Technology Co., Ltd. All rights reserved.

No parts of this publication may be reproduced or transmitted in any form or by any means, electronic or mechanical, photocopying, recording, or otherwise, for any purpose, without the express written permission of Yeastar Information Technology Co., Ltd. Under the law, reproducing includes translating into another language or format.

Declaration of Conformity



Hereby, Yeastar Information Technology Co., Ltd. declares that Yeastar S-Series IP PBX is in conformity with the essential requirements and other relevant provisions of the CE, FCC.

Warranty

The information in this document is subject to change without notice.

Yeastar Information Technology Co., Ltd. makes no warranty of any kind with regard to this guide, including, but not limited to, the implied warranties of merchantability and fitness for a particular purpose. Yeastar Information Technology Co., Ltd. shall not be liable for errors contained herein nor for incidental or consequential damages in connection with the f guide.

WEEE Warning



In accordance with the requirements of council directive 2002/96/EC on Waste of Electrical and Electronic Equipment (WEEE), ensure that at end-of-life you separate this product from other waste and scrap and deliver to the WEEE collection system in your country for recycling.

Contents

About This Guide	1
S-Series Overview	2
Introduction	2
Feature Highlights	2
Expansion Board.....	3
<i>Expansion Board – EX08</i>	3
<i>Expansion Board – EX30</i>	3
<i>D30 Module</i>	3
Hardware Overview.....	4
<i>Yeastar S20</i>	4
<i>Yeastar S50</i>	4
<i>Yeastar S100</i>	5
<i>Yeastar S300</i>	6
LED Indicators and Ports	6
<i>LED Indicators</i>	6
<i>Port Description</i>	7
Getting Started	8
Accessing Web GUI	8
Web Configuration Desktop.....	9
<i>Desktop</i>	9
<i>Taskbar</i>	9
<i>Main Menu</i>	9
<i>Options</i>	10
<i>Save and Apply Changes</i>	11
Make Your First Call	11
System Settings	12
Network.....	12
<i>Basic Settings</i>	12
<i>OpenVPN</i>	13
<i>DDNS Settings</i>	13
<i>Static Route</i>	14
Security	15
<i>Firewall Rules</i>	16
<i>IP Auto Defense</i>	17
<i>Service</i>	17
<i>Certificate</i>	19
<i>Database Grant</i>	20
User Permission.....	20
<i>Add New User Permission</i>	21
<i>User Portal</i>	21

Date & Time	22
Email	23
Storage	23
<i>Storage Devices</i>	23
<i>Storage Locations</i>	25
<i>Auto Cleanup</i>	25
Extensions	27
Add New Extension	27
Add Bulk Extensions	32
Search and Edit Extension	33
Extension Group	34
Trunks.....	35
FXO Trunk.....	35
BRI Trunk	37
GSM/CDMA/3G Trunk.....	40
VoIP Trunk	41
E1/T1/J1 Trunk.....	45
Call Control	52
Inbound Routes.....	52
Outbound Routes	54
Auto CLIP Routes.....	56
Time Conditions	57
<i>Add Time Condition</i>	57
<i>Add a Holiday</i>	58
<i>Assigning Time Conditions to Inbound Routes</i>	58
<i>Assigning Time Conditions to Outbound Routes</i>	58
Call Features	59
IVR.....	59
Ring Group.....	60
Queue	61
Conference	63
<i>Join a Conference Room</i>	63
<i>Manage the Conference</i>	63
Pickup Group	64
Speed Dial	65
Callback	67
DISA	68
Blacklist/Whitelist	69
Pin List	70
<i>Linking a PIN List to Outbound Routes/DISA</i>	71
Paging/Intercom	71

SMS	72
<i>SMS to Email</i>	72
<i>Email to SMS</i>	73
Voice Prompts	75
Prompt Preference	75
System Prompt	75
<i>Upload System Prompts</i>	75
<i>Download Online Prompt</i>	76
Music on Hold	76
Custom Prompt	77
General	79
Preference	79
Feature Code	80
Voicemail	82
<i>Voicemail to Email Template</i>	84
SIP	84
<i>General</i>	84
<i>NAT</i>	85
<i>Codec</i>	87
<i>TLS</i>	88
<i>Session Timer</i>	88
QOS	89
<i>T.38</i>	89
<i>Advanced</i>	90
IAX	90
Recording	91
Event Center	92
Event Settings	92
Notification Contacts	93
Event Log	94
CDR and Recording	95
PBX Monitor	96
Extension Status	96
Trunk Status	97
Concurrent Call	99
Resource Monitor	100
Information	100
Network	100
Performance	101
<i>CPU</i>	101

Memory	101
LAN	102
Storage Usage	102
Maintenance	103
Upgrade	103
<i>Automatic Upgrade</i>	103
<i>Browsing File from Local PC to Upgrade</i>	104
<i>Upgrade through HTTP</i>	104
<i>Upgrade through TFTP</i>	104
Backup and Restore	105
Reset and Reboot	106
System Log	107
Operation Log	107
Troubleshooting	108
<i>Ethernet Capture Tool</i>	108
<i>DAHDI Monitor Tool</i>	109
<i>IP Ping</i>	109
<i>Traceroute</i>	110
App Center	111
What App Center Offers	111
<i>PBX Center</i>	111
<i>LDAP Server</i>	111
<i>Auto Provisioning</i>	112
Install Apps	112
Manage Apps	112
LDAP Server	114
Auto Provisioning	119
Provisioning Methods	119
Auto Provisioning Settings	119
<i>Device List</i>	119
<i>Upload Files</i>	121
<i>Phonebook</i>	121
<i>Firmware Upgrade</i>	122

About This Guide

Thanks for choosing Yeastar S-Series IP PBX. This guide is intended for administrators who need to prepare for, configure and operate S-Series IP PBX. In this guide, we describe every detail on the functionality and configuration of the PBX. We begin by assuming that you are interested in S-Series IP PBX and familiar with networking and other IT disciplines.

Products Covered

This guide explains how to configure the following products:

- Yeastar S20 IP PBX
- Yeastar S50 IP PBX
- Yeastar S100 IP PBX
- Yeastar S300 IP PBX

Related Documents

The following related documents are available on Yeastar website: <http://www.yeastar.com>.

Document	Description
Yeastar S-Series Datasheet	Datasheet for the Yeastar S-Series.
Yeastar S20 Installation Guide Yeastar S50 Installation Guide Yeastar S100 Installation Guide Yeastar S300 Installation Guide	Installation guide for the Yeastar Series IP PBX.
Yeastar S-Series Extension User Guide	Users could refer to the manual for instructions on how to login the user portal, and how to configure their accounts, listen to call recordings, check voicemail messages, etc.

Safety when working with electricity



- Do not use a 3rd party power adaptor.
- Do not power on the device during the installation.
- Do not work on the device, connect or disconnect cables when lightning strikes.

S-Series Overview

This chapter provides the following sections:

- [Introduction](#)
- [Feature Highlights](#)
- [Expansion Board](#)
- [Hardware Overview](#)

Introduction

Designed with the small and medium sized enterprises in mind, supporting up to 500 users and built using the very latest technology, the Yeastar S-Series delivers exceptional cost savings, productivity and efficiency improvements, delivering power, performance, quality and peace of mind.

The all new S-Series is engineered for the communications needs of today and tomorrow, and with the Yeastar unique modular design future proofs your investment choice.

Feature Highlights

Appreciate the Easy-to-use Solution

- Intuitive and graphical UI brings point-and-click configuration.
- Convenient Phone Provisioning feature saves you tremendous time.
- Everything can be managed from anywhere with Internet access.

Your Choice of Technologies and Features

- Embedded VoIP capability and analog phone connections.
- Rich external lines options include SIP, PSTN, ISDN BRI, E1/T1/PRI, and cellular networks.
- Concurrent calls and maximum users are expandable with modules.
- App Center integrates features that you can add when you need them.

Telephone System without Risk

- Meanwell power supply featuring MTBF>560Kh.
- High-quality Freescale CPU processor and industry leading TI DSP voice processor.
- Connectors from TE Connectivity with a gold plating layer as thick as 15 μ .
- Lightning protection on analog ports complying with ITU-T K.20/45/21 8/20 μ s and GR-1089 standard.

Play Safe and Expect Reliability

- TLS, SRTP, and HTTPS standards for better security.
- Defend against malicious attack with built-in Firewall.
- Monitor system status and behavior and be notified when abnormalities occur.

Learn more about Yeastar S-Series here:

http://www.yeastar.com/S_Series_VoIP_PBX

Expansion Board

Yeastar S100 and S300 are expandable.

- S100 supports up to 2 EX08/EX30 Expansion Spans; supports 1 D30 Module.
- S300 supports up to 3 EX08/EX30 Expansion Spans; supports up to 2 D30 Modules.

Expansion Board – EX08

EX08 board supports up to 4 modules (8 ports).

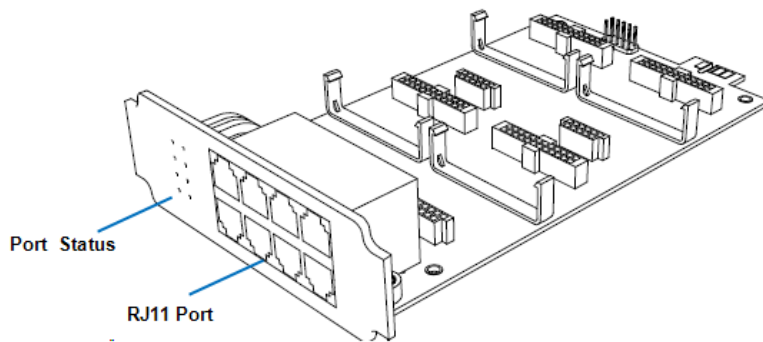

Optional Module

- O2 Module
- S2 Module
- SO Module
- B2 Module
- GSM Module
- CDMA Module
- 3G Module

Expansion Board – EX30

EX30 board supports 1 E1/T1 port.

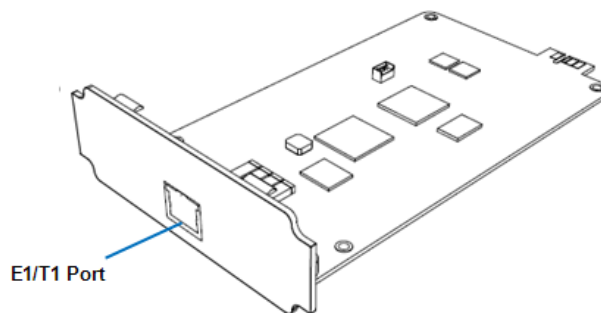

D30 Module

D30 is a DSP module, used to expand the capacity of PBX. With per D30 module added, the extensions increase 100 and concurrent calls increase 30 in additional.

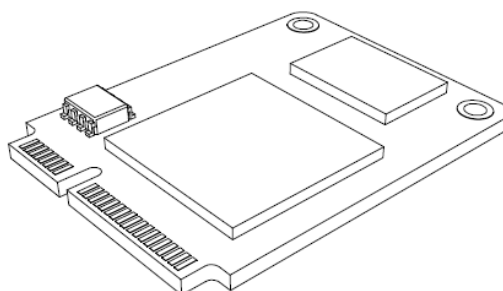

Hardware Overview

Yeastar S20

Front Panel

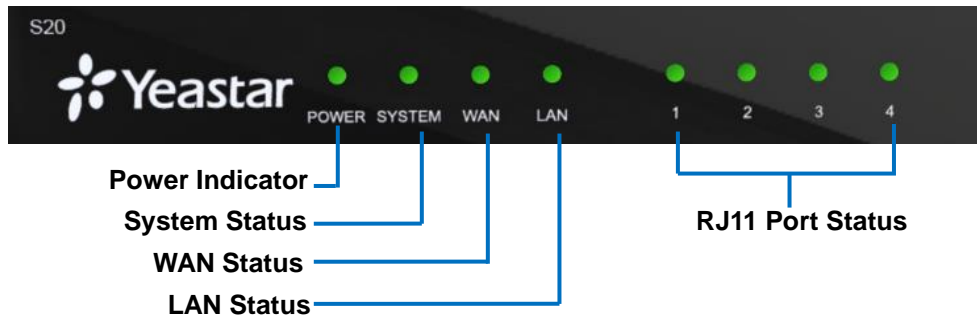

Rear Panel

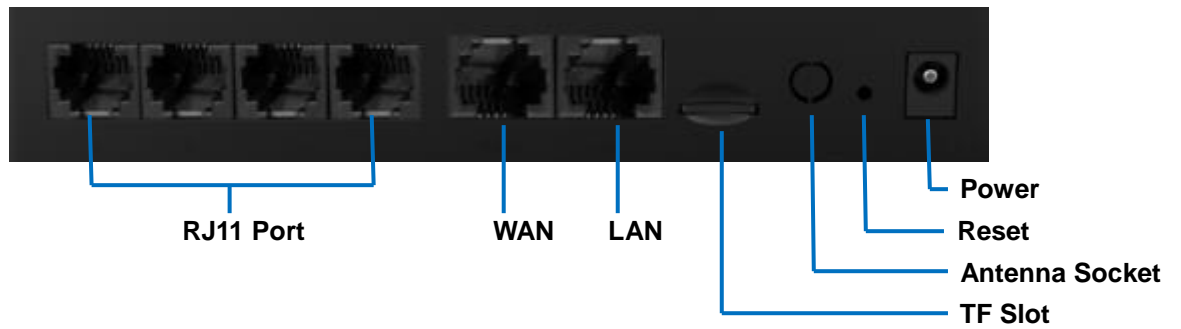

Yeastar S50

Front Panel

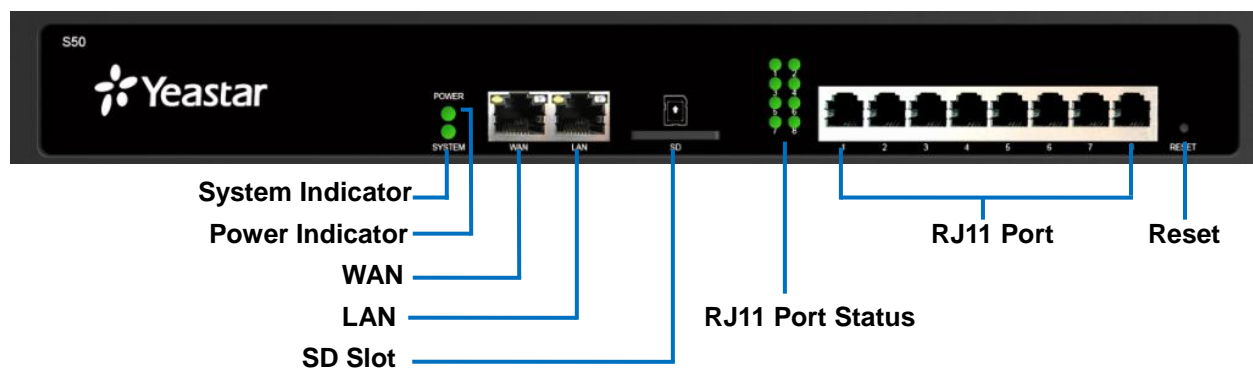

Rear Panel



Yeastar S100

Front Panel (1*EX30 + 1*EX08)



Rear Panel

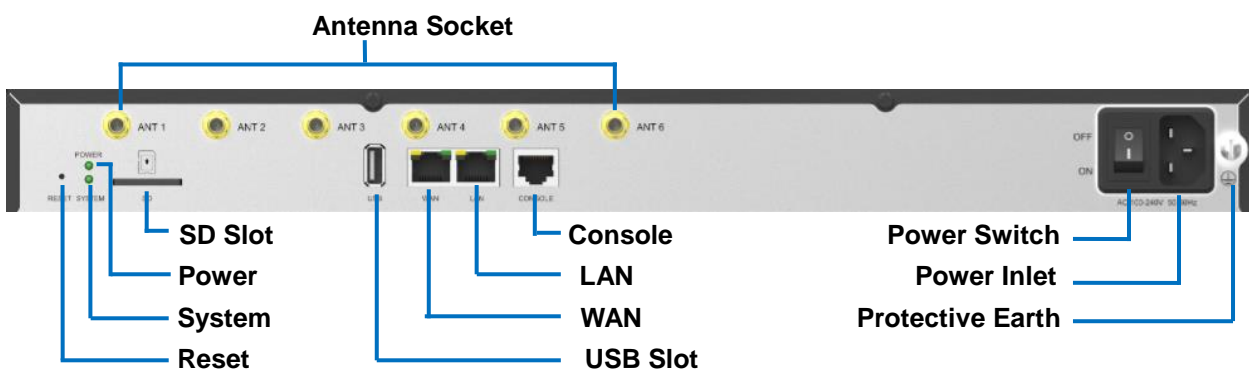

Yeastar S300

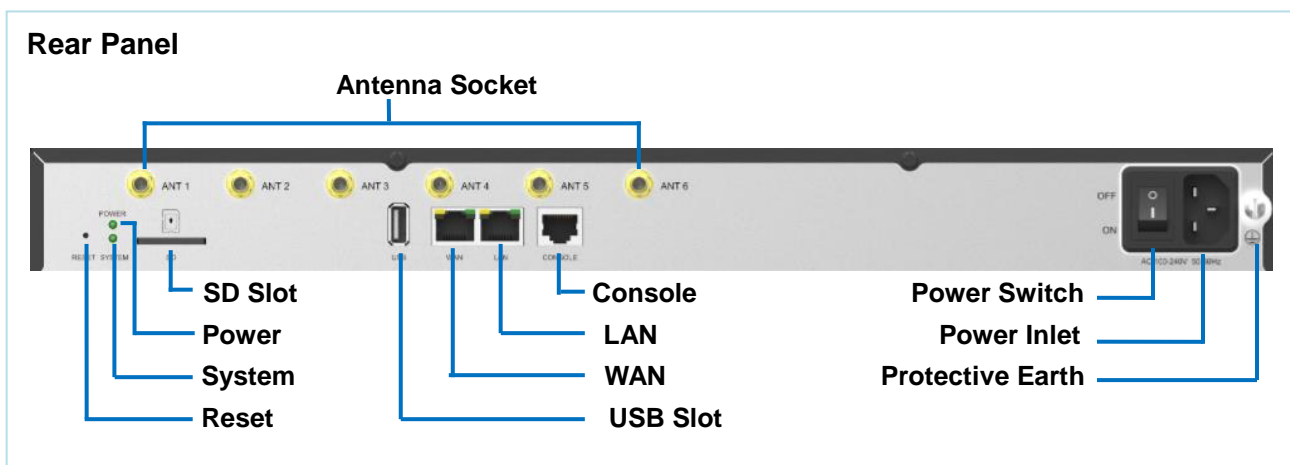
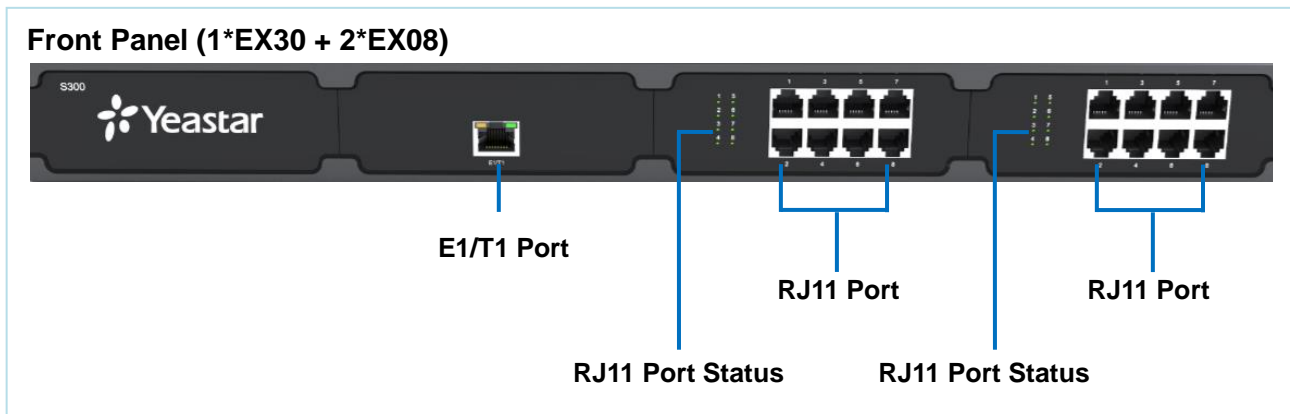

LED Indicators and Ports

LED Indicators

LED	Indication	Status	Description
POWER	Power status	On	The power is switched on
		Off	The power is switched off
System	System status	Blinking	The system is running properly
		Static/Off	The system goes wrong
WAN	WAN status	Static Green light	Linked normally, 10/100 Mbps.
		Static Orange light	Linked normally, 1000 Mbps.
		Blinking	In communication.
		Off	Off-line.
LAN	LAN status	Static Green light	Linked normally, 10/100 Mbps.
		Static Orange light	Linked normally, 1000 Mbps.
		Blinking	In communication.
		Off	Off-line.

RJ11 Port Status	FXS	Green light	<ul style="list-style-type: none"> • Static: The port is idle. • Blinking: There is an ongoing call on the port.
	GSM/CDMA/3G	Red light	<ul style="list-style-type: none"> • Static: the trunk is idle. • Blinking slowly: there is no SIM card inserted. • Blinking rapidly: the trunk is in use.
	BRI	Orange light	<ul style="list-style-type: none"> • Blinking slowly: the BRI line is disconnected. • Static: the BRI line is connected or in use.
	FXO	Red light	<ul style="list-style-type: none"> • Blinking slowly: no PSTN line is connected to the port. • Static: the PSTN line is idle. • Blinking rapidly: the PSTN line is busy.

Port Description

Ports	Description
RJ11 Port	<p>FXO port (red light): for the connection of PSTN lines or FXS ports of traditional PBX.</p> <p>FXS port (green light): for the connection of analog phones.</p> <p>BRI port (orange light): for the connection of ISDN BRI lines.</p> <p>Note: the sequence number of the ports corresponds to that of the Indicator lights in the front panel. (I.e. the LED lights in the front indicate the connection status of the corresponding ports at the front panel.)</p>
ANT	Connect to GSM/CDMA/3G Antenna.
E1/T1	Connect to E1 line or the E1 port of traditional PBX.
Console	Connect to the RS-232 Cable to debug to system.
TF Slot	Insert TF card.
SD Slot	Insert SD card.
USB Slot	Connect to USB external disk.
Ethernet Port	<p>Yeastar S20 provides two 10/100M adaptive RJ45 Ethernet ports, S50/100/300 supports two 10/100/1000M Ethernet ports. There are 2 Ethernet modes for the system. The default mode is "Bridge".</p> <ul style="list-style-type: none"> • Bridge: LAN port interface will be used for uplink connection. WAN port interface will be used as bridge for PC connection. • Dual: both ports can be used for uplink connection.
Reset Button	Press and hold for 10 seconds to restore the factory defaults
Power Inlet	Connect the supplied power supply to the port.
Power Switch	Press this button to switch on/off the device.

Getting Started

This chapter explains how to log in Yeastar S-Series Web GUI, use the taskbar and widgets, and open applications with the Main Menu.

- [Accessing Web GUI](#)
- [Web Configuration Desktop](#)
- [Make Your First Call](#)

Accessing Web GUI

Yeastar S-Series provides web-based configuration interface for administrator and extension users. The administrator can manage the device by logging in the Web interface. Check the factory defaults below:

IP address: <https://192.168.5.150:8088>

User Name: **admin**

Default Password: **password**

To log in S-Series:

- 1 Make sure your computer is connected to the same network as the IP PBX.
- 2 Start a web browser on your PC, enter the IP address, press **Enter** on your keyboard.
- 3 Enter your user name and password, click **Login**.

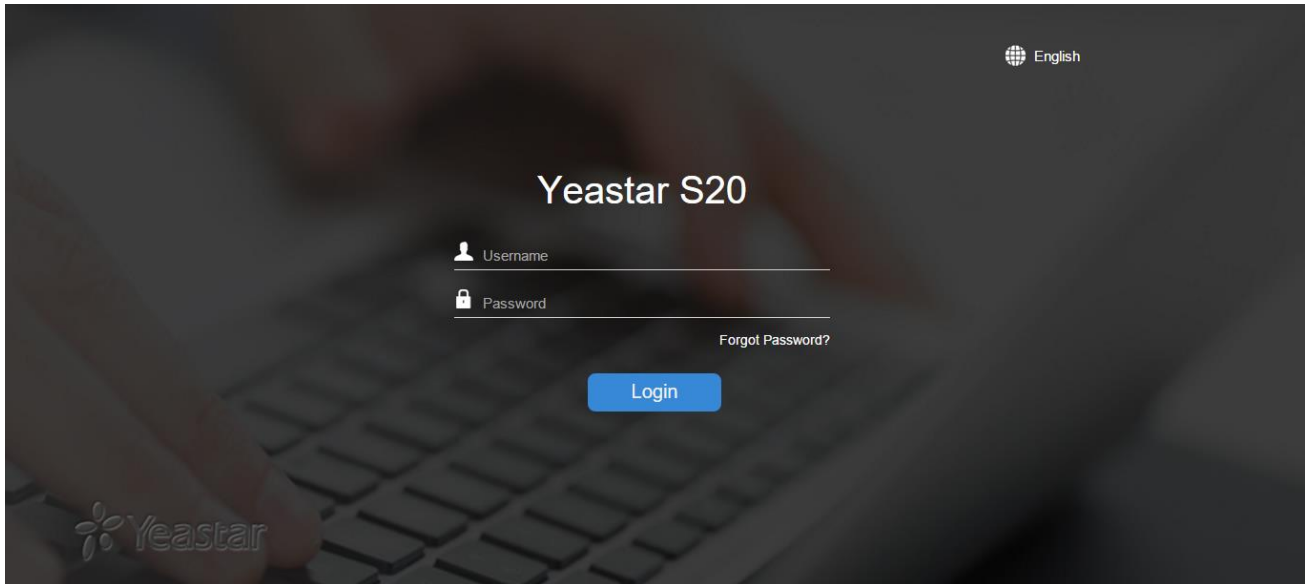

Figure 2-1 S-Series Web Configuration Panel Login Page

Note: To ensure your connection to the S-Series Web GUI runs smoothly, please use the following browsers:

- **Chrome**
- **Firefox**
- **Internet Explorer: 11.0 or later**

Web Configuration Desktop

When you log in to Yeastar S-Series Web GUI, you will see the desktop. From here, you can manage settings, install applications, or view system resource information.

Desktop

The desktop is where your application windows are displayed.



Figure 2-2 Desktop

Taskbar

The taskbar at the top of the desktop includes the following items:



Figure 2-3 Taskbar

- 1 **Main Menu:** view and open applications installed on your S-Series system. Right-click an application icon, you can add the application to desktop.
- 2 **Open Application**
 - Click the icon of an application to show or hide its window on the desktop.
 - Right-click the icon and choose from the shortcut menu to manage the application window (**Maximize, Minimize, Restore, Close**).
- 3 **Options:** logout, change Web language or modify personal account options.

Main Menu

Click the **Main Menu**  at the top-left of the desktop, you can find all the installed applications on your S-Series system.

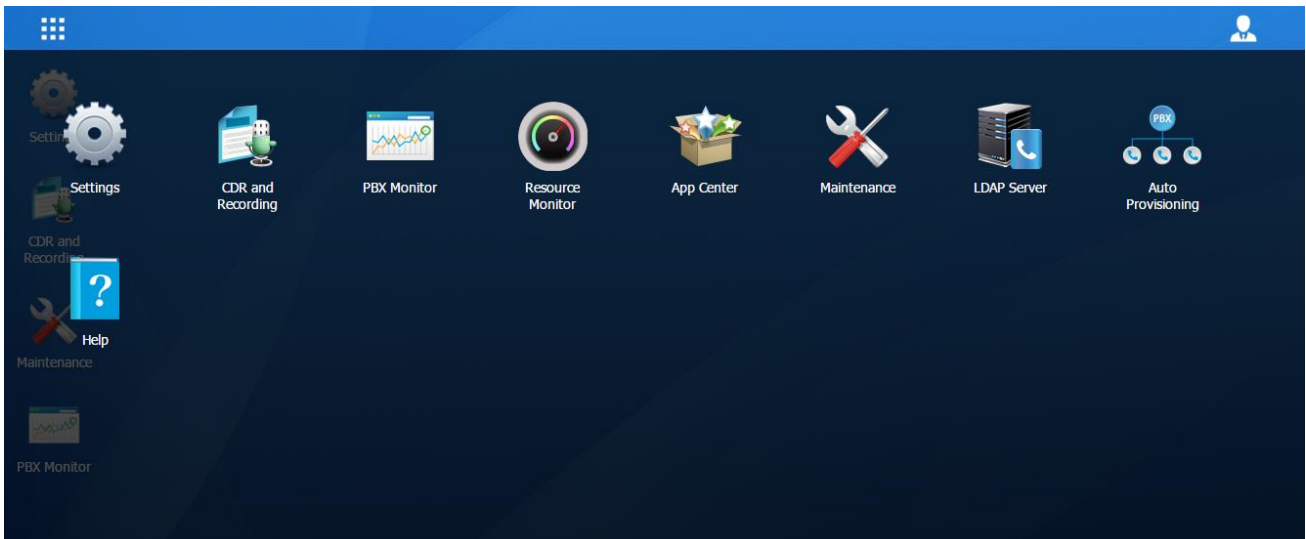

Figure 2-4 Main Menu

Options

Click the options icon  to logout, change Web language or modify your account settings.



Figure 2-5 Options

- **Language**
Select Language to change web language.
- **My Settings**
Click My Settings to modify your account settings. Here you can change the login password and bind your email address with the account.

The screenshot shows a 'My Settings' dialog box with the following fields and buttons:

- Old Password:** A text input field with a vertical cursor.
- New Password:** A text input field.
- Retype New Password:** A text input field.
- Email Address:** A text input field.
- Save** and **Cancel** buttons at the bottom.

Figure 2-6 My Settings

- **Logout**

Click Logout to log out the Web GUI.

Save and Apply Changes

Click on **Save** button after your configurations on the S-Series system, do not forget to click **Apply** button on the upper right of the desktop to submit all the changes. If the change requires reboot to take effect, the system will prompt you with a pop-up window.

Make Your First Call

Connect your IP phone and S-Series device to the same network. Then register an extension to the IP phone and make your first call through S-Series system.

- 1 Log in your S-Series Web GUI, go to **Settings > PBX > Extensions**.
- 2 Click **Add** to create a new extension, set the type as "SIP". You will need the Registration Name and Registration Password to register the extension later.
- 3 Register the extension on your phone with the Registration Name and Registration Password, the SIP server address is your S-Series IP address.
- 4 When the extensions is registered to S-Series, you can dial *2 to access your voicemail box. The default password to enter the voicemail box is your extension number.
- 5 Once entering the voicemail box, you are connected to the S-Series system!

System Settings

This chapter explains system settings on S-Series. Go to **Settings > System** to check the system settings.

- [Network](#)
- [Security](#)
- [User Permission](#)
- [Date & Time](#)
- [Email](#)
- [Storage](#)

Network

After successfully logging in the S-Series Web GUI for the first time with the factory IP address, users could go to **Settings > System > Network** to configure the network for S-Series.

Yeastar S-Series supports two Ethernet modes: Dual and Bridge.

Basic Settings

Please check the basic network settings below.

Table 3-1 Network Basic Settings Description

Basic Settings	
Hostname	Set the hostname for the system.
Mode	Select the Ethernet mode. The default mode is Bridge. <ul style="list-style-type: none"> • Bridge: LAN port interface will be used for uplink connection. WAN port interface will be used as bridge for PC connection. • Dual: the two Ethernet interfaces will use different IP addresses. Assign two IP addresses in this mode.
Default Interface	In Dual mode, you need to choose the default interface.
LAN/WAN Settings (DHCP Mode)	
If you choose this mode, the system will act as DHCP client to get an available IP address from your local network.	
LAN/WAN Settings (Static IP Address)	
IP Address	Enter the IP address (xxx.xxx.xxx.xxx).
Subnet Mask	Enter the subnet mask (xxx.xxx.xxx.xxx). For example, 255.255.255.0
Gateway	Enter the gateway address (xxx.xxx.xxx.xxx).
Preferred DNS Server	Enter the IP address of the preferred DNS server (xxx.xxx.xxx.xxx).
Alternate DNS Server	Enter the IP address of the alternative DNS server (xxx.xxx.xxx.xxx).
LAN/WAN Settings (PPPoE)	
Username	Enter the PPPoE username.
Password	Enter the PPPoE password.

VLAN	
Enable VLAN	Check this option to enable VLAN.
VLAN ID	Enter the VLAN ID.
VLAN Priority	Set the VLAN priority. The default is 0.

OpenVPN

S-Series supports OpenVPN. The system provides detailed VPN configurations on the Web GUI and you can also upload the VPN configuration package to the system to make it work.

Before using OpenVPN feature, please Enable OpenVPN first, then choose the Type to configure OpenVPN:

- Manual Configuration
- Upload OpenVPN Package

Check the VPN configurations parameters below.

Table 3-2 OpenVPN Manual Configuration Parameters Description

OpenVPN Configuration	
Server Address	Enter the server address of OpenVPN.
Server Port	Enter the server port of OpenVPN. The default is 1194.
Protocol	Select the protocol type. The server and client must use the same protocol.
Device	Select the network device. The client and server must use the same setting. <ul style="list-style-type: none"> • TUN: a TUN device is a virtual point-to-point IP link. • TAP: a TAP device is a virtual Ethernet adapter.
Username	Specify the username.
Password	Specify the password.
Encryption	Select the encryption method. The server and client must use the same setting.
Compression	Enable or disable compression for data stream. The server and client must use the same setting.
Proxy Server	Specify the proxy server.
Proxy Port	Specify the proxy port.
CA Cert	Upload a CA certificate.
Cert	Upload a Client certificate.
Key	Upload a Client key.
TLS Authentication	Enable or disable TLS authentication. If enabled, please upload a TA key via Settings > System > Security > Certificate .

DDNS Settings

Dynamic DNS or DDNS is a method of updating, in real time, a Domain Name System (DNS) to point to a changing IP address on the Internet. This is used to provide a persistent domain name for a resource that may change location on the network. DDNS is usually configured on router. If

your router cannot support DDNS, we can set up DDNS on Yeastar system.

Yeastar S-Series supports the following DDNS servers:

- dyndns.org
- freedns.afraid.org
- www.no-ip.com
- www.zoneedit.com
- www.oray.com
- 3322.org

Check the DDNS configuration parameters below.

Table 3-3 DDNS Configuration Parameters Description

DDNS	
DDNS Status	This shows the current DDNS status of the device.
Enable DDNS	Check this box to enable DDNS.
Server	Choose a DDNS provider from the list.
Username	Enter the username of your DDNS account.
Password	Enter the password of you DDNS account.
Hash	Enter your string of Hash as provided by freedns.afraid.org.
Domain	Enter the domain name.

Static Route

In computer networking, a routing table is a data table stored in a router or a networked device that lists the routes to particular network destinations, and in some cases, metrics (distances) associated with those routes. Static routes are entries made in a routing table by non-automatic means and which are fixed rather than being the result of some network topology “discovery” procedure.

Static route on the system is used to configure to route the connection, packets to particular network destinations, usually a specific gateway.

➤ Routing Table

All the static routes are displayed on the Routing Table.



Basic Settings	OpenVPN	DDNS Settings	Static Routes	
Routing Table	Static Routes			
Destination	Subnet Mask	Gateway	Metric	Interface
default	0.0.0.0	192.168.6.1	0	LAN
192.168.6.0	255.255.255.0	0.0.0.0	0	LAN

Figure 3-1 Routing Table

➤ Static Routes

Click Static Routes tab, you can add static routes here.

Click  to add a static route.

- Click  to edit the static route.
- Click  to delete the static route.

Check the Static route settings below.

Table 3-4 Static Routes Settings Description

Static Route	
Destination	<p>Enter the destination IP address or IP subnet for the S-Series to reach using the static route.</p> <p>Example:</p> <ul style="list-style-type: none"> • IP address: <i>192.168.6.120</i> • IP subnet: <i>192.168.6.0</i>
Subnet Mask	<p>Enter the subnet mask for the destination address.</p> <p>Example: <i>255.255.255.255</i></p>
Gateway	<p>Enter the gateway address. The S-Series system will reach the destination address via this gateway.</p> <p>Example: <i>192.168.6.1</i></p>
Metric	<p>The cost of a route is calculated using what are called routing metric. Routing metrics are assigned to routes by routing protocols to provide measurable values that can be used to judge how useful (how cost) a route will be.</p>
Interface	<p>Select the network interface. The system will reach the destination address using the static route through the selected network interface.</p>

Security

VoIP attack, although not an everyday occurrence does exist. When using VoIP, system security is undoubtedly one of the issues we care about most. With appropriate configuration, and some basic safety habits, we can improve the security of the telephone system. Moreover, the powerful built-in firewall function in Yeastar system is adequate to enable the system to run safely and stably.

We strongly recommend that you configure firewall and other security options to prevent the attack fraud and the system failure or calls loss.

.Firewall Rules

Users could add rules to accept or reject traffic through the system. Go to **Settings > System > Security > Firewall Rules** to configure firewall for the system.

Before adding firewall rules, please check the option **Enable Firewall**, then click **Save** to enable the firewall.

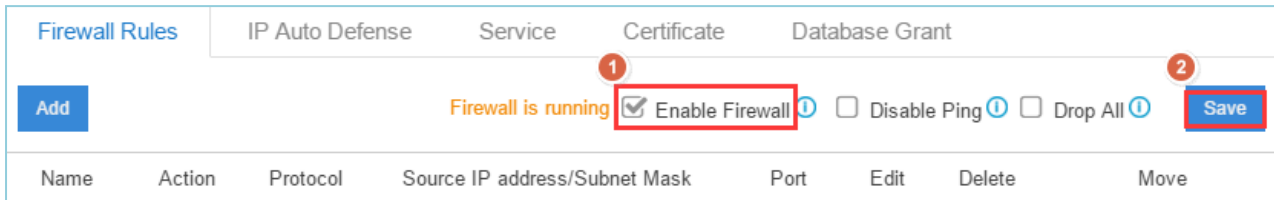





Figure 3-2 Firewall Rules

- Click  to add a new rule.
- Click  to edit the rule.
- Click  to delete the rule.

Check the firewall configuration parameters below.

Table 3-5 Firewall Configuration Parameters Description

Firewall	
Enable Firewall	Enable Firewall to protect the system from malicious attack. Click Save icon to apply the changes.
Disable Ping	Enable this item, net ping from remote hosts will be dropped. Click Save icon to apply the changes.
Drop All	When you enable Drop All feature, the system will drop all packets and connections from other hosts if there are no other rules defined. To avoid locking the device, at least one TCP Accept common rule must be created for port used for SSH access and port used for HTTP access.
Firewall Rules	
Name	Specify a name to identify the firewall rule.
Description	Description for this firewall rule.
Action	Select the action for the firewall rule: <ul style="list-style-type: none"> • Accept • Ignore • Reject
Protocol	Select the protocol applied for the rule: <ul style="list-style-type: none"> • UDP • TCP • BOTH
Source IP address/ Subnet mask	The IP address for this rule.

	Example: 192.168.5.100/255.255.255.255 means this rule is for 192.168.5.100. 192.168.5.100/255.255.255.0 is for IP from 192.168.5.0 to 192.168.5.100.
Port	Set the port for the firewall rule. The end port must be equal to or greater than start port.

IP Auto Defense

Users could create auto defense rules, then the system will prevent massive connection attempts or brute force attacks. The IP addresses would be listed in the **Block IP Address** table. There are 3 default auto defense rules, we recommend you keep the rules there.

Auto Defense Rules		Blocked IP Address			
Port	Protocol	Rate	Edit	Delete	
<input type="checkbox"/>	5060	UDP	120/60s		
<input type="checkbox"/>	5060	UDP	40/2s		
<input type="checkbox"/>	8022	TCP	5/60s		

Figure 3-3 Auto Defense Rules

Please check the auto defense rule configuration parameters below.

Table 3-6 IP Auto Defense Rule Configuration

IP Auto Defense Rule	
Port	Auto defense port, for example, 8022.
Protocol	Select auto defense protocol: <ul style="list-style-type: none"> • UDP • TCP
The Number of IP Packets	The number of IP Packets permitted within a specific time interval.
Time Interval	The time interval to receive IP Packets. For example, Number of IP Packets sets 90 and Time Interval sets 60 mean 90 IP packets are allowed in 60 seconds.

Service

The service page displays all the service status and port on S-Series.

Table 3-7 Service Configuration

Protocol or Service	Description
HTTPS	The default access protocol is HTTPS and the port is 8088.
Redirect from port 80	If the option is enabled, when you access S-Series using HTTP with port 80, it will be redirected to HTTPS with port 8088.

Certificate	If you have uploaded HTTPS certificates to S-Series, select it from the drop-down menu.
HTTP	The default port for HTTP is 80.
SSH	SSH port is used to access S-Series underlying configurations to debug the system. The default port is 8022. We recommend you disable SSH port if you do not need it.
FTP	With FTP service, you can connect to PBX via web browser. The default port is 21.
TFTP	To upload files to S-Series through TFTP, you need to enable this option.
IAX	The default port is 4569.
SIP UDP	The default port is 5060.
SIP TCP	The default port is 5060.
SIP TLS	The default port is 5061.

DHCP

Check the box **Enable DHCP Server**, S-Series will act as a DHCP server. This feature is used when you do phone provisioning through DHCP mode.

Enable DHCP Server
 DHCP is not running

Gateway ⓘ:

Subnet Mask ⓘ:

Preferred DNS Server ⓘ:

Alternate DNS Server ⓘ:

DHCP Address Range ⓘ: -

TFTP Server ⓘ:

NTP Server ⓘ:

Figure 3-4 DHCP Server

- **Gateway:** enter the gateway IP address.
- **Subnet Mask:** enter the subnet mask.
- **Preferred DNS Server:** enter the preferred DNS server.
- **Alternate DNS Server:** enter the alternate DNS server.
- **Allow IP Address:** this sets the IP address that the DHCP server can assign to network devices. Start IP address is on the left and end IP on the right.
- **TFTP Server:** this option is for Phone Provisioning feature. So IP phones can get configuration

file from this address. For Grandstream and Panasonic phones, enter the PBX's IP address, for example: 192.168.5.150. For other IP phones, remember to specify the protocol, for example, tftp://192.168.5.150.

- **NTP Server:** the PBX can be a NTP server. By default, it is the PBX's IP address.

AMI

The Asterisk Manager Interface (AMI) is a system monitoring and management interface provided by Asterisk. The 3rd party software can work with S-Series using AMI interface. The default port is 5080.

Figure 3-5 AMI Settings

- **Username:** specify a name for the AMI user.
- **Password:** specify a password for the user to connect to AMI.
- **Permitted IP/Subnet mask:** configure permitted IP address and subnet mask that would be allowed to authenticate as the AMI user. If you do not set this option, all IPs will be denied.

Certificate

S-Series supports TLS and HTTPS protocols. Before using these two protocols, you need to upload the relevant certificates to the system.

Click [Upload](#) to upload a certificate.

Figure 3-6 Certificate

- **Trusted Certificate:** This certificate is a CA certificate. When selecting "TLS Verify Client" as "Yes", you should upload a CA. The relevant TLS client (i.e. IP phone) should also have this certificate.
- **PBX Certificate:** This certificate is server certificate. No matter selecting "TLS Verify Client" as "Yes" or "NO", you

should upload this certificate to S-Series. If TLS client (i.e. IP phone) enables “TLS Verify server”, you should also upload the relevant CA certificate on IP phone.

Database Grant

Yeastar S-Series is using MySQL database. The 3rd party software can access MySQL via the Internet. Before that, you need to grant the authority to the database user. Go to Database Grant page, click **Add** to add a database user, specify the username and password.

Figure 3-7 Add Database Grant

- **Username:** configure the username which can be used by third party to access the database of PBX.
- **Password:** configure the password which can be used by third party to access the database of PBX.
- **Permitted IP:** enter the permitted IP address.

User Permission

The system has one default administrator account, which has the highest privileges. Here the administrator is referred as Super Admin. The system will automatically create user accounts when new extensions are created. By default, the extension users can log in the system and check their own settings and CDR. The Super Admin can grant more privileges for extension users. All the created users will be displayed on the User Permission page.

<input type="checkbox"/>	User	Privilege	Edit	Delete
<input type="checkbox"/>	500 - 500	Administrator		
<input type="checkbox"/>	501 - 501	Custom		

Figure 3-8 User Permission

- **Super Admin** has the highest privilege. The super administrator can access all pages on S-Series Web and make all the configurations on the system.
Username: **admin**
Default Password: **password**
- **Administrator** is created by the Super Admin. The administrator has all the privileges but



cannot create new users for login.

- **Custom User** is created by the Super Admin. The Super Admin sets the privileges for those users according to different situations.

Add New User Permission

Log in the S-Series Web GUI with the Super Admin account, go to **Settings > System > User Permission**. Click **Add** to add a new User Permission. The following window prompts. Choose the user and privilege type, then check the options to enable the privileges for the user.

Figure 3-9 Add New User Permission

Once created, the Super Admin can edit the users by clicking  or delete the users by clicking .

User Portal

The extension user could log in S-Series Web GUI with the extension username and password. The extension user account is created automatically when an extension is created on the system.

- **Username:** extension number (i.e. 1000)
- **Default password:** “pass” plus extension number (i.e. pass1000)

Below is an example of login page using extension number 1000.

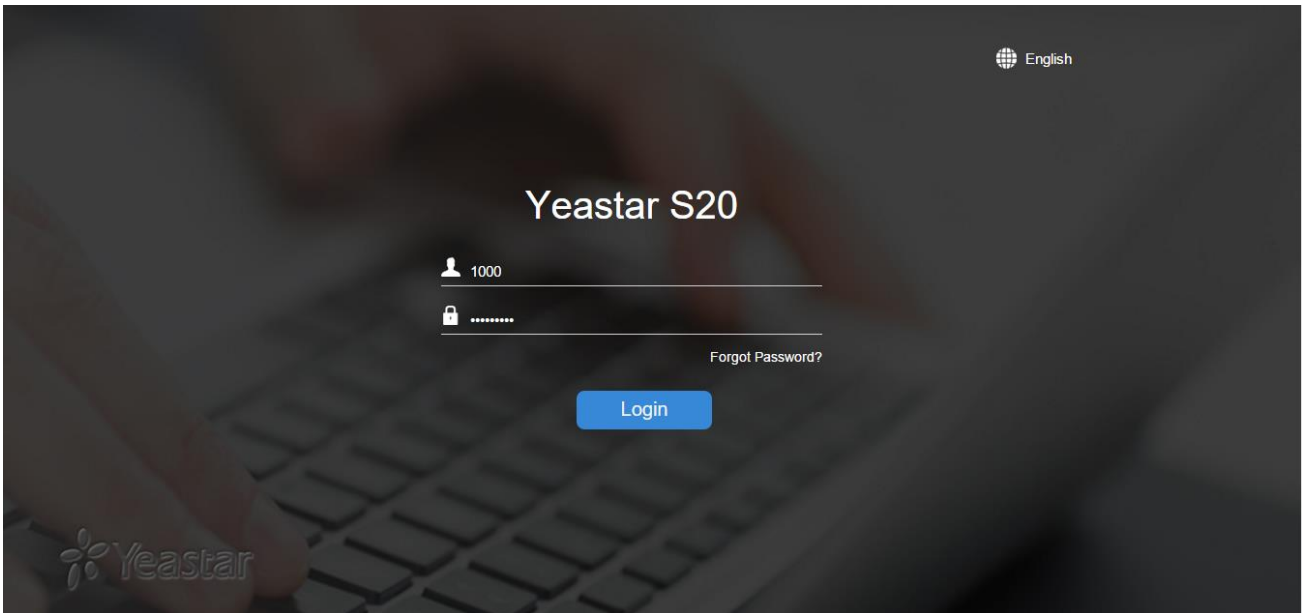

Figure 3-10 User Portal

Date & Time

Go to **Settings > System > Date & Time** to check the current time on the system. Here you can adjust time of the system (including time zone) to your local time.

Figure 3-11 Date & Time

- **Time Zone:** select your current time zone.
- **Daylight Saving Time:** the option is disabled by default. Enable it when necessary.
- **Synchronize With NTP Server:** if you choose this mode, the system will adjust its internal clock to a central network server. Please note S-Series should be able to access the Internet if you choose this mode.
 - NTP Server: enter a NTP server.
- **Set Up Manually:** if you choose this mode, you need to set the time manually.

- Date: choose the date.
- Time: choose the time.

Email

Set the system's email to send voicemail to email, alert event emails, fax to email, email to SMS and SMS to email. Go to **Settings > System > Email** to configure the system email.

Check the email settings parameters below.

Table 3-8 Email Settings

Option	Description
Email Address	Enter the email address.
Password	Enter the password.
Outgoing Mail Server (SMTP)	Enter SMTP server and port. Example: <i>smtp.sina.com:25</i>
Incoming Mail Server (POP3)	Enter the POP3 server and port. Example: <i>pop.sina.com:110</i>
Enable TLS	Use TLS to send secure message to server .If the email sending server needs to authenticate the sender, you need to select the checkbox. Note: if you use Gmail or Exchange, you need enable this option.

After finishing the configuration, click **Test** to test the email. In the prompt, fill in an email address to send a test email to verify the Email settings.

Storage

Yeastar S-Series provides local storage (Flash) and supports external storage TF/SD card. Users could choose where to store the voicemails, CDR, recordings and logs.

Storage Devices

Go to **Settings > System > Storage** to configure the storage. All the local storage and external storage status shows on the page.

Storage Devices						
Name	Type	Total	Available Size	Usage	Configure	Unmount NetDisk
Local	LOCAL	3.02G	2.95G	3%		
TF/SD	TF/SD	0.00G	0.00G	Not Inserted		

Figure 3-12 Storage Devices

To format a external storage:

1. Click .
2. Click **Format** on the pop-up window to start formatting.

To add Network Drive:

The Network Drive feature is used to extend storage space. Before network drive can be properly configured, an SMB share folder accessible from Yeastar system must be set up on a Windows based machine. Once that has been set up, please follow the following instructions to configure network drive:

1. Choose a window-based computer that is always in service.
2. Create a folder.
3. Share this folder to Everyone.
4. Click **Add Network Drive** and input the Net-Disk information in Yeastar S-Series:

Add Network Drive ×

Running Status:

Name :

Host/IP :

Share Name :

Access Username :

Access Password :

Figure 3-13 Add Network Disk

- **Name:** give this network drive a name to help you identify it.
 - **Host/IP:** set the IP address where the recordings will be stored.
 - **Share Name:** the shared folder name where the recordings will be stored.
 - **Access User Name:** the User name used to log in the Network share. Leave this blank if it is not required. In general, you use the administrator account on PC as a user name here.
 - **Access Password:** the password used to log into the network share. Leave this blank if it is not required.
5. If the configuration is correct, you can see the NETDISK status shown as below.



Figure 3-14 Network Disk Status

Storage Locations

When the storage devices are configured and ready to use, you can select where to store CDR, Recordings, Voicemail, one-touch recordings, logs.

The screenshot shows the 'Storage Locations' configuration page. It contains four dropdown menus: 'CDR' set to 'Local', 'Recordings' set to '[None]', 'Voicemail & One Touch Recordings' set to 'Local', and 'Logs' set to 'Local'. Each dropdown has an information icon to its left.

Figure 3-15 Storage Locations

Auto Cleanup

Yeastar S-Series supports auto clean for CDR, logs, voicemails, one-touch recordings and recordings.

Table 3-9 Auto Cleanup Settings

CDR Auto Cleanup	
Max Number of CDR	Set the maximum number of CDR that should be retained. The default is 100000. The old CDR will be deleted when the threshold is reached.
CDR Preservation Duration	Set the maximum number of days that CDR should be retained. The default is left blank.
Voicemail and One Touch Recording Auto Cleanup	
Max Number of Files	Set the maximum number of voicemail and one touch recording files that should be retained. The default is 50. The old CDR will be deleted when the threshold is reached.
Files Preservation Duration	Set the maximum number of minutes that voicemails and one touch recordings should be retained. The default is left blank.
Recordings Auto Cleanup	
Max Usage of Device	Set the maximum storage percentage the device is allowed to store. The default is 80%. The recordings will be deleted when the

	threshold is reached.
Recordings Preservation Duration	Set the maximum number of days that recording files should be retained. The default is left blank.
Logs Auto Cleanup	
Logs Preservation Duration	Set the maximum number of days that logs should be retained. The default is 7.
Max Number of Logs	Set the maximum number of logs that should be retained. The default is unlimited. The old logs will be deleted when the threshold is reached.

Extensions

This chapter explains how to create and configure extensions on S-Series. Yeastar S-Series supports SIP, IAX and FXS extensions. An extension can be set to the 3 types and be registered to different devices. Go to **PBX > Extensions** page to configure the extensions.

- [Add New Extension](#)
- [Add Bulk Extensions](#)
- [Search and Edit Extension](#)
- [Extension Group](#)

Add New Extension

Click [Add](#) to add a new extension, you will see the pop-up window appear as below.

The screenshot shows a pop-up window titled "Add Extension" with a close button (X) in the top right corner. The window has four tabs: "Basic", "Features", "Advanced", and "Call Permission". The "Basic" tab is selected and active. Under the "Basic" tab, there are two sections: "General" and "User Information".

General Section:

- Type: Radio buttons for SIP (checked), IAX, and FXS. A dropdown menu is to the right.
- Extension: Text input field containing "1008".
- Registration Name: Text input field containing "1008".
- Concurrent Registrations: Spin box set to "1".
- Caller ID: Text input field containing "1008".
- Registration Password: Text input field containing "Chhtyr87".

User Information Section:

- Name: Text input field containing "1008".
- Email: Empty text input field.
- Prompt Language: Dropdown menu set to "English System Pro".
- User Password: Password input field with masked characters "*****".
- Mobile Number: Empty text input field.

At the bottom of the window, there are two buttons: "Save" and "Cancel".

Figure 4-1 Add New Extension

Extension settings are divided to 4 categories:

- Basic
- Feature
- Advanced
- Call Permission

Click on the tab to view or edit the relevant settings. Check the configuration parameters below.

Note: different settings would appear for different types of extension.

- **Basic Settings**

Table 4-1 Extension Configuration Parameters – Basic

General	
Type	Check the box to set the extension type. You can set the extension to multiple types. <ul style="list-style-type: none"> • SIP • IAX • FXS: S2 or SO module should be installed on the device if you want to create FXS extension.
Extension	The extension number that will be associated with this particular user or phone.
Caller ID	The Caller ID string that appears on outbound calls for this extension.
Registration Name	For extension registration validation.
Registration Password	The password for the user to register the SIP or IAX account. For example, 12t3f6.
Concurrent Registrations	Yeastar S-Series IP PBX supports SIP forking. SIP forking refers to the process of “forking” a single SIP call to multiple SIP endpoints. The value of Concurrent Registrations limits how many SIP endpoints the extension can be registered.
User Information	
Name	A character-based name for this user. For example, Bob Jones.
User Password	The password for this extension user to log in the system. For example, 12t3f6.
Email	Email address of this extension user. The email will be used to recover password, receive forwarding voicemails, receive fax as an attachment, and receive event notifications.
Mobile Number	Mobile Number of this user. The number can receive forwarded calls and event notifications.
Prompt Language	The language of voice prompts. The default is the same with system language. If more language options are needed, please download it from "System Prompts" under "Voice Prompts".

- **Features**

Table 4-2 Extension Configuration Parameters – Features

Voicemail	
Enable Voicemail	Check this box to enable voicemail for this extension.
Send Voicemail to Email	Check this box to send voicemail to the user's email address. Note: to use this feature, "Email Settings" under "System" need to be configured correctly.
Voicemail Access PIN	Voicemail password used to access Voicemail system. This password can contain only numbers.
Call Forwarding	

Always	<p>Always redirect the call to the designated destination.</p> <ul style="list-style-type: none"> • Voicemail: redirect the caller to leave a voice message. • Extension: redirect the caller to another extension. • Users' Mobile Number: redirect the caller to the mobile number filled in User Information. • Custom Number: fill in the number manually and redirect the caller to this number.
No Answer	Redirect the call to the designated destination when it is not answered.
When Busy	Redirect the call when the extension is busy.
Mobility Extension	
Enable Mobility Extension	If you enable this setting, when the User's Mobile Number dial into the system, the phone will have the same user permission with the desktop extension. So the mobile number will be able to reach the other extension, dial out with the trunk, and play voicemail.
Mobility Extension	It is the same with the User's Mobile Number. A prefix matching the outbound route also needs to be filled in.
Ring Simultaneously	When the extension has an incoming call, it rings the mobile number simultaneously.
Monitor Settings	
Allow Being Monitored	Check this option to allow this user to be monitored.
Monitor Mode	<p>Decide how you will monitor another extension's current call.</p> <ul style="list-style-type: none"> • None: you will not be allowed to monitor other's call. • Extensive: all the following 3 modes will be available to use. • Listen: you can only listen to the call, but can't talk (default feature code: *90). • Whisper: you can talk to the extension you're monitoring without being heard by the other party (default feature code: *91). • Barge-in: you can talk to both parties (default feature code: *92).
Other Settings	
Ring Timeout	Customize the timeout in seconds. Phone will stop ringing over the time defined.
Max Call Duration	<p>Select the maximum call duration in seconds for every call of this extension. If you wish to customize, enter the value in the text box directly. This option is valid only for outbound calls.</p> <p>If you choose "Follow System", it would be equal to the "Max Call Duration" value in the "General" page.</p>
Call Waiting	Check this option if the extension should have Call Waiting capability. If this option is checked, the "When busy" call forwarding options will not be available. The call waiting function of IP phone has higher priority than MyPBX call waiting function.

DND	Don't Disturb. When DND is enabled for an extension, the extension will not be available.
-----	---

- **Advanced Settings**

Table 4-3 Extension Configuration Parameters – Advanced

VoIP Settings	
NAT	This setting should be used when the system is using a public IP address, communicating with devices hidden behind a NAT device (such as a broadband router). If you have one-way audio problems, you usually have problems with your NAT configuration or your firewall's support of SIP and/or RTP ports.
Qualify	Check the box to send SIP OPTIONS regularly to the device to check if the device is still online.
Enable SRTP	Enable SRTP for voice encryption.
Register Remotely	Check the box to allow registration of a remote extension.
Transport	Select the allowed transport.
DTMF Mode	Set the default mode for sending DTMF tones. <ul style="list-style-type: none"> • RFC4733: DTMF will be carried in the RTP stream in different RTP packets than the audio signal • Info: DTMF will be carried in the SIP Info messages • Inband: DTMF will be carried in the audio signal • Auto: will use RFC4733 or Info automatically. RFC4733 is the default mode.
IP Restriction	
Enable IP Restriction	This option is used for IP access control. Check this option to enhance the VoIP security. Once enabled, only the IP address or IP section match the settings will be able to register this extension number.
Permitted IP/Subnet mask	Define the IP address or IP section which is allowed to register to the PBX. The input format should be IP address/Subnet mask. <p>Example:</p> <ul style="list-style-type: none"> • 192.168.5.100/255.255.255.255 means only the device whose IP address is 192.168.5.100 is allowed to register this extension number; • 192.168.5.0/255.255.255.0 means only the device whose IP section is 192.168.5.XXX is allowed to register this extension number.
Analog Settings	
Min Flash Detection	Set the minimum amount of time, in milliseconds, that a hook flash must remain depressed in order for the system to consider it as a valid flash event. The default is 300 ms.

Max Flash Detection	Set the maximum amount of time, in milliseconds, that a hook flash must remain depressed in order for the system to consider it as a valid flash event. The default is 1000 ms.
Echo Cancellation	Enable or disable echo cancellation on the FXS port.
Rx Volume	The volume of the voice sent from the analog phone to the FXS port of PBX. Set the value from 5% to 100% or choose Custom to define the RX gain below.
Rx Gain	The gain of the voice sent from the analog phone to the FXS port of PBX. (Unit: db). The valid range is -30db to 6.0db.
Tx Volume	The volume of the voice sent from the FXS port of PBX to the analog phone. Set the value from 5% to 100% or choose Custom to define the TX gain below.
Tx Gain	The gain of the voice sent from the FXS port of PBX to the analog phone. (Unit: db) The valid range is -30db to 6.0db.

- **Call Permission**

Choose the outbound routes the user is allowed to use.

The screenshot displays the 'Call Permission' configuration page. At the top, there are tabs for 'Basic', 'Features', 'Advanced', and 'Call Permission'. Below the tabs, the 'Outbound Routes' section is active. It features two main containers: 'Available' on the left and 'Selected' on the right. The 'Available' container lists 'Routeout'. A vertical stack of navigation buttons is positioned between the two containers, including arrows for moving items between lists and a double arrow for clearing the selected list. At the bottom of the page, there are 'Save' and 'Cancel' buttons.

Figure 4-2 Call Permission

Add Bulk Extensions

You can batch add SIP/IAX extensions on the system, which help you add a large amount of extensions quickly. Click **Bulk Add** to add extensions in bulk.

The screenshot shows the 'Add Bulk Extensions' configuration window. It has four tabs: 'Basic', 'Features', 'Advanced', and 'Call Permission'. The 'Basic' tab is selected. Under the 'General' section, there are several configuration options:

- Type:** Radio buttons for 'SIP' (checked) and 'IAX' (unchecked).
- Start Extension:** A text input field containing '1001'.
- Create Number:** A spinner control set to '5'.
- Registration Password:** A dropdown menu set to 'Random'.
- User Password:** A dropdown menu set to 'Prefix + Extension'.
- Prefix Password:** A text input field containing 'pass'.
- Concurrent Registrations:** A spinner control set to '1'.
- Prompt Language:** A dropdown menu set to 'System Default'.



Figure 4-3 Add Bulk Extensions

Table 4-4 Bulk Add Extensions Configuration Parameters

General	
Type	Choose the type for the extensions: <ul style="list-style-type: none"> SIP IAX
Start Extension	Set the starting extension number of the batch of extensions to be added.
Create Number	The number of extensions to be created.
Register Password	Decide which type of registration password will be used. There are 3 options. <ul style="list-style-type: none"> Random: generate a random password for each extension. Fixed: use the text filled in as the password for all extensions. Prefix + extension number: fill in a prefix and the password will be the text plus the extension's number.
User Password	Decide which type of user password will be used. There are 3 options. <ul style="list-style-type: none"> Extension: use extension number as password for each extension. Fixed: use the text filled in as the password for all extensions. Prefix + extension number: fill in a prefix and the password will be the text plus the extension's number.

Concurrent Registrations	Set the max concurrent registrations for SIP extensions.
Prompt Language	Set the language of voice prompt for extensions.

Search and Edit Extension

All the extensions are listed on the extension page. Each extension has a checkbox for you to edit or delete in bulk. Also, you can edit or delete per extension by clicking  or .























Extensions		Extension Group					
				Extension, Name, Type 			
				<input type="button" value="Add"/> <input type="button" value="Bulk Add"/> <input type="button" value="Edit"/> <input type="button" value="Delete"/>			
<input type="checkbox"/>	Extension	Name	Type	Port	Edit	Delete	
<input type="checkbox"/>	1000	1000	FXS	Port3			
<input type="checkbox"/>	1001	1001	FXS	Port4			
<input type="checkbox"/>	1002	1002	SIP				
<input type="checkbox"/>	1003	1003	SIP				
<input type="checkbox"/>	1004	1004	SIP				
<input type="checkbox"/>	1005	1005	SIP				
<input type="checkbox"/>	1006	1006	SIP				
<input type="checkbox"/>	1007	1007	SIP				
<input type="checkbox"/>	1008	1008	SIP				
<input type="checkbox"/>	1009	1009	SIP				

Figure 4-4 Extensions List

- **Search Extension**
You can search extensions by entering the extension number, name or type.
- **Edit an Extension**
Click  to edit the desired extension.
- **Delete an Extension**
Click  to delete the desired extension.
- **Bulk Edit Extensions**
Select the checkbox for the extensions, click to edit the extensions.
- **Bulk Delete Extensions**
Select the checkbox for the extensions, click to delete the extensions.

Extension Group

Extension Group feature allows you to assign and categorize extensions in different groups, which helps you to better manage the configurations in the system. For example, you can create Support and Sales groups, when configuring Outbound Route, you can select a extension group instead of each extension. This feature simplifies the configuration process.

Click **Add** to create an extension group.

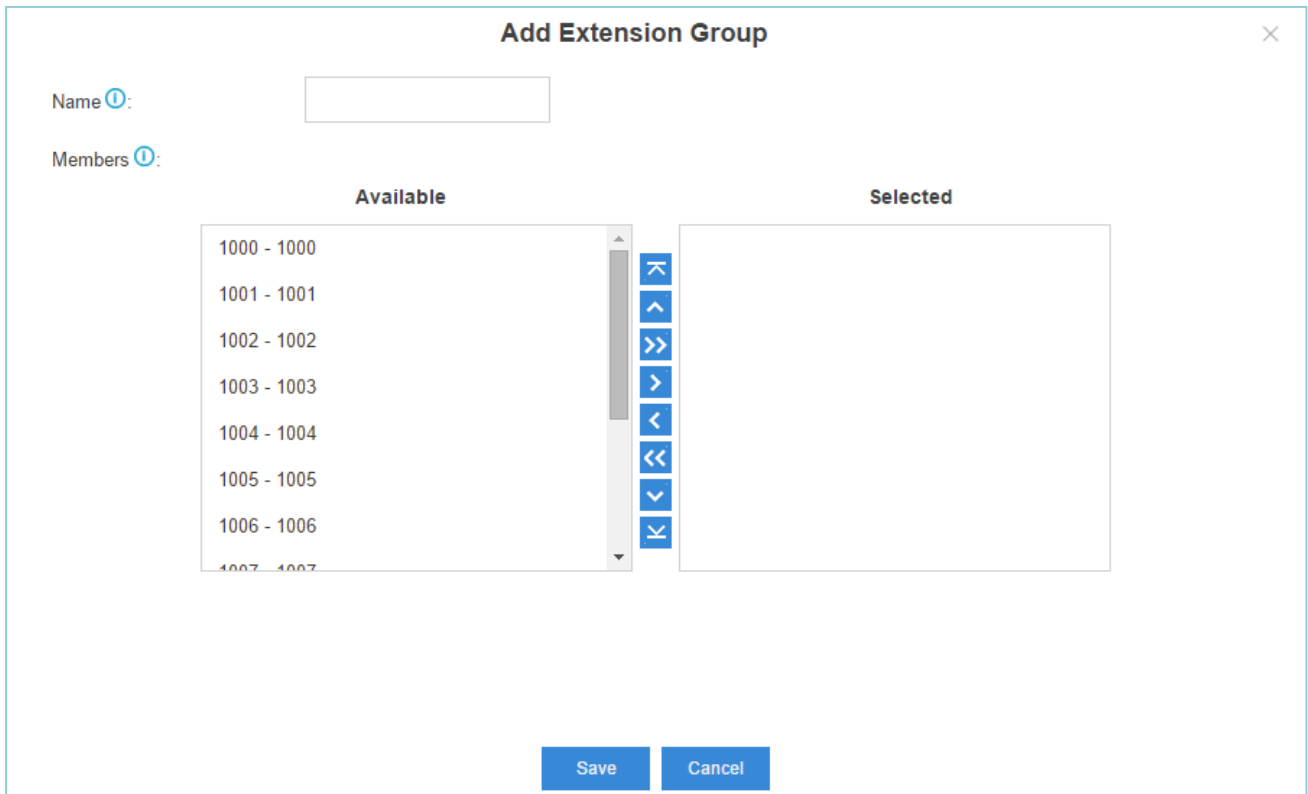

The screenshot shows a dialog box titled "Add Extension Group". It features a "Name" input field and a "Members" section. The "Members" section is divided into two columns: "Available" and "Selected". The "Available" column contains a list of extension ranges: 1000 - 1000, 1001 - 1001, 1002 - 1002, 1003 - 1003, 1004 - 1004, 1005 - 1005, 1006 - 1006, and 1007 - 1007. To the right of this list are several blue arrow buttons for moving items between the columns. At the bottom of the dialog are "Save" and "Cancel" buttons.

Figure 4-5 Add Extension Group

Trunks

Yeastar S-Series supports FXO trunk, BRI trunk, GSM/CDMA/3G trunk, VoIP trunk and E1 trunk. In this chapter, we give a simplified guide of setting up trunks.

- [FXO Trunk](#)
- [BRI Trunk](#)
- [GSM/CDMA/3G Trunk](#)
- [VoIP Trunk](#)
- [E1/T1/J1 Trunk](#)

FXO Trunk

FXO trunk is also known as PSTN trunk. The public switched telephone network (PSTN) is the network of the world's public circuit-switched telephone networks.

To extend FXO trunk on the system, you need to insert O2 or SO module to PBX. Go to **Settings > PBX > Trunks** to edit the FXO trunk. Before configuring a FXO trunk, please make sure that the analog line is connected to S-Series FXO port.

Click  to edit the FXO trunk. Please check the FXO trunk configuration parameters below.

1) Basic Settings

Table 5-1 FXO Trunk Configuration Parameters – Basic

General	
Trunk Name	Give this trunk a name to help you identify this trunk.
Rx Volume	Set the receiving volume of FXO port or choose Custom to define the RX gain below.
RxGain	The RX Gain for the receiving channel of FXO Port. The valid range is -30db to 12db.
Tx Volume	Set the transmitting volume of FXO port or choose Custom to define the TX gain below.
TxGain	The TX Gain for the transmitting channel of FXO Port. The valid range is -30db to 12db.

2) Hangup Detection

Hangup detection settings help the system to detect if a call is hung up. If you find the PSTN call could not be disconnected, these settings need to be configured.

Table 5-2 Hangup Detection Configuration Parameters

Option	Description
Hangup Detection Method	Detect if a call is hung up with one of the following methods: <ul style="list-style-type: none"> • Busy Tone: listen for a busy tone to detect if the line got hung

	<p>up.</p> <ul style="list-style-type: none"> • Polarity Reversal: the call will be considered as “hang up” on a polarity reversal.
Busy Count	Specify how many busy tones to wait for before hanging up. The default is 4. If you wish to customize, enter the value in the text box directly. Setting this too high might cause failure of busy detection.
Busy Pattern	<p>Select the cadence of your busy signal. The default is None. If you wish to customize, enter the value in the text box directly. The input format should be "Sound,Silence". E.g. "500,500" means 500ms on, 500ms off.</p> <ul style="list-style-type: none"> • If you choose None, the system will accept any regular sound-silence pattern that repeats Busy Count times as a busy signal. • If you specify Busy Pattern, the system will further check the length of the tone and silence, which will further reduce the chance of a false positive disconnection.
Busy Interval	The busy detection interval. The default is 1. If you wish to customize, enter the value in the text box directly.
Frequency Detection	Decide whether to enable detecting the busy signal frequency or not.
Busy Frequency	If Frequency Detection is enabled, you must specify the local frequency. The default is 480,620. If you wish to customize, enter the value in the text box directly. Unit: Hz.

3) Answer Detection Type

Answer Detection will help the system to accurately bill your calls.

- None:
- Polarity: choose this option if the FXO trunk could send polarity reversal signal after a call is established.

4) Caller ID Settings

Caller ID Settings will help the system to detect Caller ID. If an incoming PSTN call does not display Caller ID, you need to confirm with your service provider if the line has enabled Caller ID feature. If this line does support Caller ID, configure these settings to solve this problem.

Table 5-3 Caller ID Configuration Parameters

Option	Description
Caller ID Detection	Whether to enable Caller ID detection.
Caller ID Start	<p>Define the start of a Caller ID signal. The options are:</p> <ul style="list-style-type: none"> • After Ring: detect Caller ID after first ring; • Before Ring: detect Caller ID before first ring; • After Polarity: detect Caller ID after polarity reversal; <p>The default is After Ring.</p>

Caller ID Signaling	<p>This option defines the type of caller ID signaling to use.</p> <ul style="list-style-type: none"> • Bell202 • ETSI-V23 • V23-Japan • DTMF
---------------------	---

5) Other Settings

Table 5-4 Other Settings

Option	Description
Ring Detect Timeout	FXO (FXS devices) must have a timeout to determine if there was a hangup before the line is answered. This value can be used to configure how long it takes before the system considers a non-ringing line with hangup activity. The default is 5000. If you wish to customize, enter the value in the text box directly. The valid range is 1000-8000.
Enable DNIS	Dialed Number Identification Service is a telephone service that enables a company to identify which telephone number was dialed. Users could configure DNIS to allow the IP phones to display which trunk is passing the call.
DNIS Name	A name for this DNIS, when a call reaches the selected trunk, the name will be displayed on the ringing phone.

BRI Trunk

Basic Rate Interface (BRI, 2B+D, 2B1D) is an Integrated Services Digital Network (ISDN) configuration intended primarily for use in subscriber lines similar to those that have long been used for plain old telephone service. The BRI configuration provides 2 bearer channels (B channels) at 64 kbit/s each and 1 data channel (D channel) at 16 kbit/s. The B channels are used for voice or user data, and the D channel is used for any combination of data, control/signalling, and X.25 packet networking.

To extend BRI trunk on the system, you need to insert B2 module to S-Series and connect the BRI port to the BRI provider with a RJ45-RJ11 cable.

Go to **Settings > PBX > Trunks**, click  to edit the BRI trunk. Please check the BRI trunk configuration parameters below.

1) Basic Settings

Table 5-5 BRI Trunk Configuration Parameters – Basic

General	
Trunk Name	Give this trunk a name to help you identify this trunk.
Signaling	Specify the Signaling type according to the direction provided by your service provider.

Signaling Role	Specify whether this interface will act like the user or the network. The default is User.
Switch Type	Configure the switch type according to the direction provided by your service provider.

2) Advanced Settings

Table 5-6 BRI Trunk Configuration Parameters – Advanced

Advanced	
Echo Cancellation	This option enables or disables echo cancellation. The default is checked.
Codec	Choose the codec for this trunk.
Facility-based ISDN Supplementary Services	Decide whether to enable transmission of facility-based ISDN supplementary services (such as caller name from CPE over facility) or not. The default is checked.
Overlap Dial	Define whether the system can dial this switch using overlap digits or not. If you need Direct Dial-in, then enable this option. The default is unchecked.
Reset Interval	This sets the time in seconds between restart of unused B channels. Set the interval to Never if you don't like the channel to restarts. The default is Never.
PRI Indication	<p>Tells how PBX should indicate busy and congestion to the switch/user. The options are:</p> <ul style="list-style-type: none"> Inband: PBX plays indication tones without answering; not available on all PRI/BRI subscription lines; Out-of-Band: PBX disconnects with busy/congestion information code so the switch will play the indication tones to the caller. <p>The default is Out-of-Band.</p>
Enable DNIS	Dialed Number Identification Service is a telephone service that enables a company to identify which telephone number was dialed. Users could configure DNIS to allow the IP phones to display which trunk is passing the call.
DNIS Name	A name for this DNIS, when a call reaches the selected trunk, the name will be displayed on the ringing phone.
DID Number	This number is used to identify which line of the trunk is passing the call.
Hide Caller ID	Whether to hide caller ID or not.
Dialplan	
Calling Party Numbering Plan	Select the Calling Party Numbering Plan.
Calling Party Numbering Type	Select the Calling Party Numbering Type.

Called Party Numbering Plan	Select the Called Party Numbering Plan.
Called Party Numbering Type	Select the Called Party Numbering Type.
Presentation Indicator	The PI provides instructions on whether or not the provided calling line identity is allowed to be presented, or indicate that the number is not available.
Screen Indicator	The SI provides information on the source and the quality of the provided information.
ISDN Dialplan	ISDN/telephony numbering plan (Recommendation E.164)
International Prefix	Dialplan: '(Remote Dialplan:ISDN +) Remote Number Type:international'.
National Prefix	Dialplan: '(Remote Dialplan:ISDN +)Remote Number Type:national'.
Local Prefix	Dialplan: '(Remote Dialplan:ISDN +)Remote Number Type:subscriber'.
Private Prefix	Dialplan: 'Remote Dialplan:private + Remote Number Type: subscriber'.
Unknown Prefix	Dialplan: '(Remote Dialplan:ISDN +)Remote Number Type:unknown'.

3) DOD

DOD (Direct Outward Dialing) means the caller ID displayed when dialing out. Before configuring this, please make sure the provider supports this feature.

- **Global DOD**

Configure Global direct outward dialing number. DOD (Direct Outward Dialing) is the caller ID displayed when dialing out. Before configuring this, please make sure the carrier supports this feature.

- **Add one DOD with Multiple Extensions**

Enter one DOD number and select multiple extensions.

The screenshot shows a configuration window for adding a Direct Outward Dialing (DOD) number. At the top, there is a label 'Add DOD' with a help icon and a text input field containing the number '5503309'. Below this, the interface is divided into two main sections: 'Available' and 'Selected'. The 'Available' section contains a list of extension ranges: 505 - 505, 504 - 504, 506 - 506, 508 - 508, 507 - 507, and 509 - 509. The 'Selected' section contains a list of extension ranges: 500 - 500, 501 - 501, 502 - 502, and 503 - 503. Between these two lists are four blue arrow buttons: a double right arrow (>>), a single right arrow (>), a single left arrow (<), and a double left arrow (<<). At the bottom of the window are two buttons: 'Ensure' and 'Cancel'.

Figure 5-1 Add One DOD with Multiple Extensions

- **Bind Consecutive DOD Numbers to Multiple Extensions**

Enter the DOD number range and select the extensions.

Figure 5-2 Bind Consecutive DOD Numbers to Multiple Extensions

GSM/CDMA/3G Trunk

Yeastar S-Series supports GSM/CDMA/3G trunk. To extend the trunk, you need to install GSM/CDMA/3G module to the S-Series and insert SIM card on the module.

Click  to edit the trunk. Please check the GSM/CDMA/3G trunk configuration parameters below.

Table 5-7 GSM/CDMA/3G Trunk Configuration Parameters

Option	Description
Trunk Name	Give this trunk a name to help you identify this trunk.
PIN Code	Enter the SIM card PIN code if the card has one. Note: if you failed to enter your correct PIN code 3 times in succession, the SIM card will be permanently locked, which means you would need a new card.
Rx Volume	Set the receiving volume of GSM port or choose Custom to define the RX gain below.
RX Gain (db)	The RX Gain for the receiving channel of GSM Port. The valid range is -20db to 20db.
Tx Volume	Set the transmitting volume of GSM port or choose Custom to define the TX gain below.
TX Gain (db)	The TX Gain for the transmitting channel of GSM Port. The valid range is -20db to 20db.
Enable DNIS	Dialed Number Identification Service is a telephone service that enables a company to identify which telephone number was dialed. Users could configure DNIS to allow the IP phones to display which trunk is passing the call.

DNIS Name	A name for this DNIS, when a call reaches the selected trunk, the name will be displayed on the ringing phone.
-----------	--

VoIP Trunk

Yeastar S-Series supports SIP and IAX protocols and provides 2 types of VoIP trunks:

- **Register Trunk:** registration based VoIP trunk. A Register Trunk requires S-Series to register with the provider using an authentication name and password.
- **Peer Trunk:** IP based VoIP trunk. A Peer VoIP trunk does not require S-Series to register with the provider. The IP address of S-Series needs to be configured with the provider, so that it knows where calls to your number should be routed.

Go to **Settings > PBX > Trunks** to add a VoIP trunk.

Please note that choosing different trunk protocol would have different settings.

1) Basic Settings

Table 5-8 SIP Register Trunk Configuration Parameters - Basic

SIP Register Trunk	
Protocol	Set the trunk protocol "SIP".
Trunk Type	Choose the trunk type "Register Trunk".
Provider Name	Give this trunk a name to help you identify this trunk.
Transport	Set the transport method used by the trunk. If Hostname/IP Address is the PBX's Hostname and the port is 0 or blank, NAPTR and SRV lookup will be executed to search for transport, port and server. If Hostname/IP Address is a legal IP address or a designated port, then UDP will be used.
Hostname/IP	Service provider's hostname or IP address. The default SIP port is 5060.
Domain	VoIP provider's server domain name. If the provider has no domain name, fill in the IP address instead.
User Name	The username used to register to the trunk from the VoIP provider.
Password	The password to register to the trunk from the VoIP provider.
From User	All outgoing calls from the SIP trunk will use the From User (in this case the account name for SIP Registration) in From Header of the SIP Invite package. Keep this field blank if not needed.
Authentication Name	Used for SIP authentication. In most cases, it is the same with the username.
Enable Outbound Proxy	A proxy that receives requests from a client. Even though it may not be the server resolved by the Request-URI.
Outbound Proxy Server	Configure the address of outbound proxy server. The address can

	be domain name or IP address.
--	-------------------------------

Table 5-9 SIP Peer Trunk Configuration Parameters - Basic

SIP Peer Trunk	
Protocol	Set the trunk protocol as "SIP".
Trunk Type	Choose the trunk type "Peer Trunk".
Provider Name	Give this trunk a name to help you identify this trunk.
Transport	Set the transport method used by the trunk. If Hostname/IP Address is the PBX's Hostname and the port is 0 or blank, NAPTR and SRV lookup will be executed to search for transport, port and server. If Hostname/IP Address is a legal IP address or a designated port, then UDP will be used.
Hostname/IP	Service provider's hostname or IP address. The default SIP port is 5060.
Domain	VoIP provider's server domain name. If the provider has no domain name, fill in the IP address instead.

Table 5-10 IAX Register Trunk Configuration Parameters - Basic

IAX Register Trunk	
Protocol	Set the trunk protocol "IAX".
Trunk Type	Choose the trunk type "Register Trunk".
Provider Name	Give this trunk a name to help you identify this trunk.
Hostname/IP	Service provider's hostname or IP address. The default IAX port is 4569.
User Name	The username used to register to the trunk from the VoIP provider.
Password	The password to register to the trunk from the VoIP provider.

Table 5-11 IAX Peer Trunk Configuration Parameters - Basic

IAX Peer Trunk	
Protocol	Set the trunk protocol "IAX".
Trunk Type	Choose the trunk type "Peer Trunk".
Provider Name	Give this trunk a name to help you identify this trunk.
Hostname/IP	Service provider's hostname or IP address. The default IAX port is 4569.
Domain	VoIP provider's server domain name. If the provider has no domain name, fill in the IP address instead.

2) Codec

Select codec for the VoIP trunk. Yeastar S-Series supports the codecs: a-law, u-law, GSM, iLBC, SPEEX, G722, G726, ADPCM, G729A, H261, H263, H263P, H264, MPEG4 and iLBC.

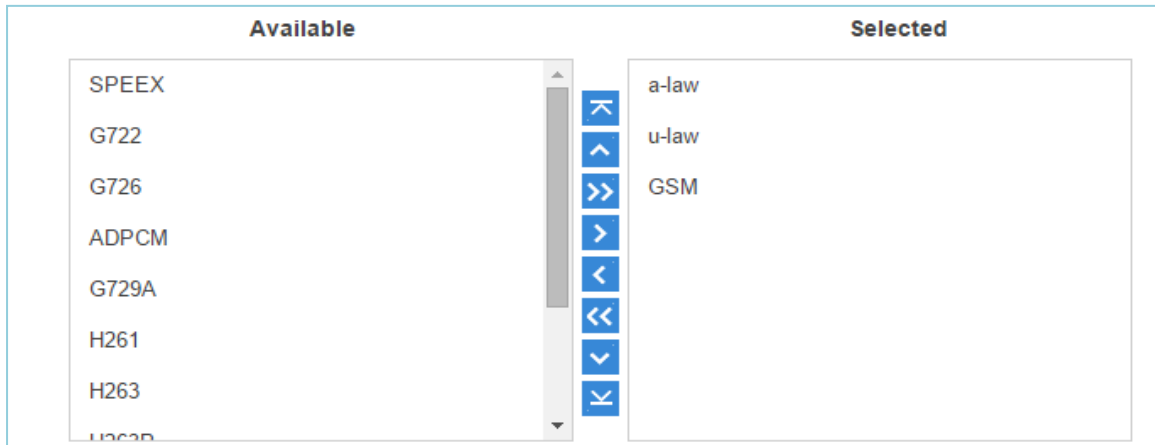

Figure 5-3 VoIP Trunk Codec

3) Advanced

Table 5-12 VoIP Trunk Configuration Parameters - Advanced

VoIP Settings	
Qualify	Enable this to send SIP OPTIONS packet to SIP device to check if the device is up.
Enable SRTP	This option enables or disable SRTP (encrypted RTP) for the trunk.
T.38 Support	Whether to enable T.38 fax for the trunk.
DTMF Mode	Set the default mode for sending DTMF tones. <ul style="list-style-type: none"> • RFC4733: DTMF will be carried in the RTP stream in different RTP packets than the audio signal • Info: DTMF will be carried in the SIP Info messages • Inband: DTMF will be carried in the audio signal • Auto: will attempt to detect if the device supports RFC4733 DTMF. If so, it will choose RFC4733; if not, it will choose Inband. RFC4733 is the default mode.
Other Settings	
Realm	Realm is a string to be displayed to users so they know which username and password to use. If you don't know what to fill in, contact your service provider for further instructions.
Send Privacy ID	Check this checkbox to send privacy ID.
Enable DNIS	Dialed Number Identification Service is a telephone service that enables a company to identify which telephone number was dialed. Users could configure DNIS to allow the IP phones to display which trunk is passing the call.
DID Number	This number is used to identify which line of the trunk is passing the call.
DNIS Name	A name for this DNIS, when a call reaches the selected trunk, the name will be displayed on the ringing phone.

4) DOD

DOD (Direct Outward Dialing) means the caller ID displayed when dialing out. Before configuring this, please make sure the provider supports this feature.

- **Global DOD**

Configure Global direct outward dialing number. DOD (Direct Outward Dialing) is the caller ID displayed when dialing out. Before configuring this, please make sure the carrier supports this feature.

- **Add One DOD with Multiple Extensions**

Enter one DOD number and select multiple extensions.

The screenshot shows the 'Add DOD' configuration window. At the top, there is a text input field labeled 'Add DOD ⓘ' containing the number '5503309'. Below this are two columns: 'Available' and 'Selected'. The 'Available' column contains a list of extension ranges: 505 - 505, 504 - 504, 506 - 506, 508 - 508, 507 - 507, and 509 - 509. The 'Selected' column contains a list of extension ranges: 500 - 500, 501 - 501, 502 - 502, and 503 - 503. Between the columns are four blue arrow buttons: a double right arrow (>>), a single right arrow (>), a single left arrow (<), and a double left arrow (<<). At the bottom of the window are two blue buttons: 'Ensure' and 'Cancel'.

Figure 5-4 Add One DOD with Multiple Extensions

- **Bind Consecutive DOD Numbers to Multiple Extensions**

Enter the DOD number range and select the extensions.

The screenshot shows the 'Add DOD' configuration window. At the top, there is a text input field labeled 'Add DOD ⓘ' containing the range '5503300-5503305'. Below this are two columns: 'Available' and 'Selected'. The 'Available' column contains a list of extension ranges: 506 - 506, 507 - 507, 508 - 508, and 509 - 509. The 'Selected' column contains a list of extension ranges: 500 - 500, 501 - 501, 502 - 502, 503 - 503, 504 - 504, and 505 - 505. Between the columns are four blue arrow buttons: a double right arrow (>>), a single right arrow (>), a single left arrow (<), and a double left arrow (<<). At the bottom of the window are two blue buttons: 'Ensure' and 'Cancel'.

Figure 5-5 Bind Consecutive DOD Numbers to Multiple Extensions

E1/T1/J1 Trunk

Yeastar S100 supports expanding up to 2 digital trunks, S300 supports expanding up to 3 digital trunks.

Go to **Settings > PBX > Trunks** to edit the digital trunk.

Please note that choosing different trunk signaling would have different settings.

1) Basic Settings

Table 5-13 PRI Trunk Configuration Parameters

PRI Signaling	
Trunk Name	Give this trunk a name to help you identify this trunk.
Interface Type	Specify the interface type according to the trunk specification.
Signaling	Specify the Signaling type according to the direction provided by your service provider.
Framing	<p>Choose the frame format for this trunk.</p> <p>When the Interface Type is E1, the options are:</p> <ul style="list-style-type: none"> • Enable CRC4 • Disable CRC4 <p>CRC4 is a method of checking for errors in data transmitted on E1 trunk lines.</p> <p>When the Interface Type is T1 or J1, the options are:</p> <ul style="list-style-type: none"> • ESF • D4
Line Code	<p>Choose the line code for this trunk.</p> <p>When the interface Type is E1, the options are:</p> <ul style="list-style-type: none"> • HDB3 • AMI <p>When the Interface Type is T1 or J1, the options are:</p> <ul style="list-style-type: none"> • B8ZS • AMI
Codec	Choose the codec for this trunk.
Echo Cancellation	This option enables or disables echo cancellation. The default is checked.
D Channel	<p>Set the channel used to carry control information and signaling information.</p> <p>When the Interface Type is E1, enter a channel number from 1 to 31.</p> <p>When the Interface Type is T1 or J1, enter a channel number from 1 to 24.</p>
Switch Type	Configure the switch type according to the direction provided by

	your service provider.
Signaling Role	Specify whether this interface will act like the user or the network. The default is User.
Overlap Dial	Define whether the system can dial this switch using overlap digits or not. If you need Direct Dial-in, then enable this option. The default is Disable.

Table 5-14 MFC/R2 Trunk Configuration Parameters

MFC/R2 Signaling	
Trunk Name	Give this trunk a name to help you identify this trunk.
Framing	Choose the frame format for this trunk. When the Interface Type is E1, the options are: <ul style="list-style-type: none"> • Enable CRC4 • Disable CRC4 CRC4 is a method of checking for errors in data transmitted on E1 trunk lines. When the Interface Type is T1 or J1, the options are: <ul style="list-style-type: none"> • ESF • D4
Line Code	Choose the line code for this trunk. When the interface Type is E1, the options are: <ul style="list-style-type: none"> • HDB3 • AMI When the Interface Type is T1 or J1, the options are: <ul style="list-style-type: none"> • B8ZS • AMI
Echo Cancellation	This option enables or disables echo cancellation. The default is checked.
Variant	Set the MFC/R2 variant.
Category	Set the category of calling party.
MAX DNIS	Select max amount of DNIS to ask for.If you wish to customize, enter the value in the text box directly.
MAX ANI	Max amount of ANI to ask for.If you wish to customize, enter the value in the text box directly.

Table 5-15 SS7 Trunk Configuration Parameters

SS7 Signaling	
Trunk Name	Give this trunk a name to help you identify this trunk.
Framing	Choose the frame format for this trunk. When the Interface Type is E1, the options are: <ul style="list-style-type: none"> • Enable CRC4 • Disable CRC4

	<p>CRC4 is a method of checking for errors in data transmitted on E1 trunk lines.</p> <p>When the Interface Type is T1 or J1, the options are:</p> <ul style="list-style-type: none"> • ESF • D4
Line Code	<p>Choose the line code for this trunk.</p> <p>When the interface Type is E1, the options are:</p> <ul style="list-style-type: none"> • HDB3 • AMI <p>When the Interface Type is T1 or J1, the options are:</p> <ul style="list-style-type: none"> • B8ZS • AMI
Codec	Choose the codec for this trunk.
Echo Cancellation	This option enables or disables echo cancellation. The default is checked.
D Channel	<p>Set the channel used to carry control information and signaling information.</p> <p>When the Interface Type is E1, enter a channel number from 1 to 31.</p> <p>When the Interface Type is T1 or J1, enter a channel number from 1 to 24.</p>
Variant	<p>Specify the SS7 Singalling variant. The options are:</p> <ul style="list-style-type: none"> • ITU: 14 bits • ANSI: 24 bits • China: 24 bits
Link set	Define SS7 linkset numbers.
Network Indicator	Specify the network indicator according to the network environment.
SLC	Specify the Signaling Link Code.
OPC	Specify the Originating Point Code. This is generally assigned by your carrier.
DPC	Specify the Destination Point Code. This is generally assigned by your carrier.

Table 5-16 E&M Trunk Configuration Parameters

E&M Signaling	
Trunk Name	Give this trunk a name to help you identify this trunk.
Interface Type	Specify the interface type according to the trunk specification.
Framing	<p>Choose the frame format for this trunk.</p> <p>When the Interface Type is E1, the options are:</p> <ul style="list-style-type: none"> • Enable CRC4 • Disable CRC4 <p>CRC4 is a method of checking for errors in data transmitted on E1</p>

	trunk lines. When the Interface Type is T1 or J1, the options are: <ul style="list-style-type: none"> • ESF • D4
Line Code	Choose the line code for this trunk. When the interface Type is E1, the options are: <ul style="list-style-type: none"> • HDB3 • AMI When the Interface Type is T1 or J1, the options are: <ul style="list-style-type: none"> • B8ZS • AMI
Codec	Choose the codec for this trunk.
Echo Cancellation	This option enables or disables echo cancellation. The default is checked.

2) Advanced

Table 5-17 PRI Trunk Configuration Parameters - Advanced

PRI Signaling		
Facility-based Supplementary Services	ISDN	Decide whether to enable transmission of facility-based ISDN supplementary services (such as caller name from CPE over facility) or not. The default is checked.
Reset Interval		This sets the time in seconds between restart of unused B channels. Set the interval to Never if you don't like the channel to restarts. The default is Never.
PRI Indication		Tells how PBX should indicate busy and congestion to the switch/user. The options are: <ul style="list-style-type: none"> • Inband: PBX plays indication tones without answering; not available on all PRI/BRI subscription lines; • Out-of-Band: PBX disconnects with busy/congestion information code so the switch will play the indication tones to the caller. The default is Out-of-Band.
Enable DNIS		Dialed Number Identification Service is a telephone service that enables a company to identify which telephone number was dialed. Users could configure DNIS to allow the IP phones to display which trunk is passing the call.
DID Number		This number is used to identify which line of the trunk is passing the call.
DNIS Name		A name for this DNIS, when a call reaches the selected trunk, the name will be displayed on the ringing phone.
DialPlan		
Calling Party Numbering Plan		Select the Calling Party Numbering Plan.

Calling Party Numbering Type	Select the Calling Party Numbering Type.
Called Party Numbering Plan	Select the Called Party Numbering Plan.
Called Party Numbering Type	Select the Called Party Numbering Type.
Presentation Indicator	The PI provides instructions on whether or not the provided calling line identity is allowed to be presented, or indicate that the number is not available.
Screen Indicator	The SI provides information on the source and the quality of the provided information.
ISDN Dialplan	ISDN/telephony numbering plan (Recommendation E.164)
International Prefix	Dialplan: '(Remote Dialplan:ISDN +) Remote Number Type: international'.
National Prefix	Dialplan: '(Remote Dialplan:ISDN +)Remote Number Type:national'.
Local Prefix	Dialplan: '(Remote Dialplan:ISDN +)Remote Number Type:subscriber'.
Private Prefix	Dialplan: 'Remote Dialplan:private + Remote Number Type: subscriber'.
Unknown Prefix	Dialplan: '(Remote Dialplan:ISDN +)Remote Number Type:unknown'.

Table 5-18 MFC/R2 Trunk Configuration Parameters - Advanced

MFC/R2 Signaling	
Enable DNIS	Dialed Number Identification Service is a telephone service that enables a company to identify which telephone number was dialed. Users could configure DNIS to allow the IP phones to display which trunk is passing the call.
DID Number	This number is used to identify which line of the trunk is passing the call.
DNIS Name	A name for this DNIS, when a call reaches the selected trunk, the name will be displayed on the ringing phone.
Forced Release	This option enables or disables forced release of channel. The default is unchecked.
Immediate Accept	Most variants of MFC/R2 offer a way to go directly to the call accepted state, by passing the use of group B and II tones. This option enables or disables the use of that feature for incoming calls. The default is unchecked.
Double Answer	Block collect calls with double answer. This will cause that every answer signal is changed by answer -> clear back -> answer. The default is unchecked.
Charge Calls	Whether or not report to the other end "accept call with charge".
Allow Collect Calls	Specify whether to accept collect calls or not.

MF Back Timeout	MFC/R2 value in milliseconds for the MF timeout. The default is None.
Metering Pulse Timeout	MFC/R2 value in milliseconds for the metering pulse timeout. Enter -1 to use the default value.
DTMF Detection Timeout	Specify the DTMF Detection timeout in milliseconds. The default is 5000 ms.
Incoming DTMF Mode	Specify the incoming DTMF mode.
First Number of Get	Choose which number to get first.
Outgoing DTMF Mode	Specify the outgoing DTMF mode.

Table 5-19 SS7 Trunk Configuration Parameters - Advanced

SS7 Signaling	
Enable DNIS	Dialed Number Identification Service is a telephone service that enables a company to identify which telephone number was dialed. Users could configure DNIS to allow the IP phones to display which trunk is passing the call.
DID Number	This number is used to identify which line of the trunk is passing the call.
DNIS Name	A name for this DNIS, when a call reaches the selected trunk, the name will be displayed on the ringing phone.
Start CIC No.	Specify the Circuit Identification Code number of the first B channel of E1 line (SS7). Note: the suggested value is the multiples of 32 plus 1, for example: 1, 33, 65...
Calling Party Number Type	Calling Party Numbering Type
Called Party Number Type	Called Party Number Type

3) DOD

DOD (Direct Outward Dialing) means the caller ID displayed when dialing out. Before configuring this, please make sure the provider supports this feature.

- **Global DOD**

Configure Global direct outward dialing number. DOD (Direct Outward Dialing) is the caller ID displayed when dialing out. Before configuring this, please make sure the carrier supports this feature.

- **Add One DOD with Multiple Extensions**

Enter one DOD number and select multiple extensions.

The screenshot shows the 'Add DOD' configuration window. At the top, the 'Add DOD' label is followed by a text input field containing the number '5503309'. Below this are two columns: 'Available' and 'Selected'. The 'Available' column lists extension ranges: 505 - 505, 504 - 504, 506 - 506, 508 - 508, 507 - 507, and 509 - 509. The 'Selected' column lists extension ranges: 500 - 500, 501 - 501, 502 - 502, and 503 - 503. Between the columns are four blue arrow buttons: '>>', '>', '<', and '<<'. At the bottom are two blue buttons: 'Ensure' and 'Cancel'.

Figure 5-6 Add One DOD with Multiple Extensions

- Bind Consecutive DOD Numbers to Multiple Extensions**
 Enter the DOD number range and select the extensions.

The screenshot shows the 'Add DOD' configuration window. At the top, the 'Add DOD' label is followed by a text input field containing the range '5503300-5503305'. Below this are two columns: 'Available' and 'Selected'. The 'Available' column lists extension ranges: 506 - 506, 507 - 507, 508 - 508, and 509 - 509. The 'Selected' column lists extension ranges: 500 - 500, 501 - 501, 502 - 502, 503 - 503, 504 - 504, and 505 - 505. Between the columns are four blue arrow buttons: '>>', '>', '<', and '<<'. At the bottom are two blue buttons: 'Ensure' and 'Cancel'.

Figure 5-7 Bind Consecutive DOD Numbers to Multiple Extensions

Call Control

This chapter shows you how to control outgoing calls and incoming calls.

- [Inbound Routes](#)
- [Outbound Routes](#)
- [Auto CLIP Routes](#)
- [Time Conditions](#)

Inbound Routes

When a call comes into S-Series from the outside, S-Series needs to know where to direct it. It can be directed to an extension, a ring group, a queue or a digital Receptionist (IVR) etc.

Go to **Settings > PBX > Call Control > Inbound Routes** to edit inbound routes.

Please check the inbound route configuration parameters below.

1) Route Name

Give this inbound route a brief name to help you identify it.

2) DID Pattern

Match the DID Pattern in this field to pass incoming call through. Leave this blank to match calls with any or no DID info. You can use a pattern match to map a range of numbers. Only Peer to Peer Trunk, BRI Trunk, SIP Trunk need to configure this option.

In patterns, the following characters have special meanings:

Table 6-1 DID Patterns Description

Patterns	
X	Refers to any digit between 0 and 9
Z	Refers to any digit between 1 and 9
N	Refers to any digit between 2 and 9
[###]	Refers to any digit in the brackets, example [123] is 1 or 2 or 3. Note that multiple numbers can be separated by commas and ranges of numbers can be specified with a dash ([1.3.6-8]) would match the numbers 1,3,6,7 and 8.
. (dot)	Wildcard. Match any number of anything.
!	Used to initiate call processing as soon as it can be determined that no other matches are possible.

If you want to route consecutive DID numbers to a range of consecutive extensions directly through SIP, SIP Peer to Peer, IAX Peer to Peer trunk, you need to enter the DID number range (separate the first number and the last number by "-"), choose the Destination as Extension Range, and fill in the relevant extension numbers (separated by "-").

3) Caller ID Pattern

Define the Caller ID Number that is allowed to call in through this inbound route. Leave this field blank to match any or no CID info. You can also use patterns match to map a range of numbers. Press Enter to input multiple patterns.

4) Member Trunks

Select which trunks will be used in this route. To make a trunk a member of this route, please move it to the "Selected" box.

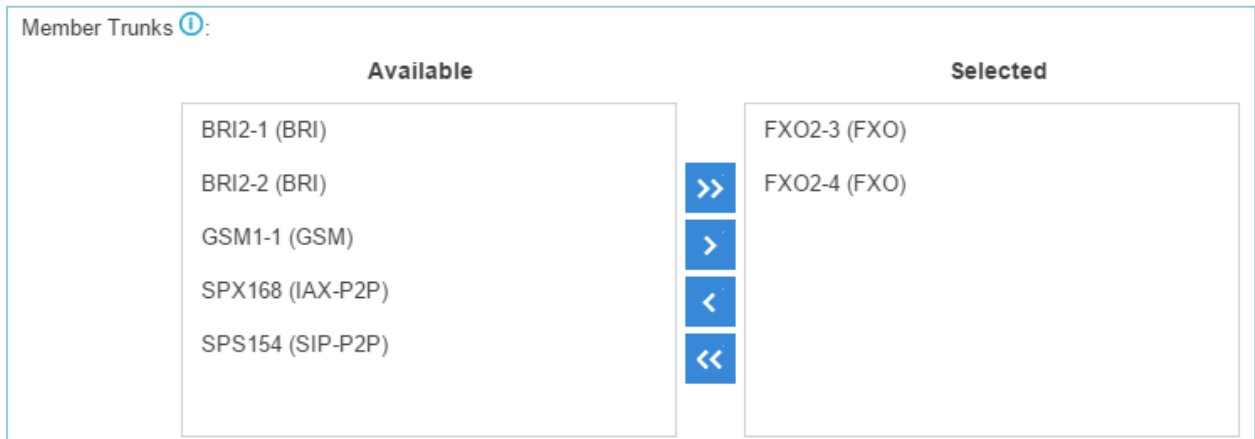

Figure 6-1 Member Trunks

5) Enable Time Condition

Decide if you want to route incoming calls based on Time Condition.

- If disabled, all calls will be routed to the Destination.
- If enabled, you could route calls to different destinations at different time. Calls that do not match the time periods will be routed to "Other Time" destination. The system will assign each Time Condition with a feature code, so you could use this code to force change the destination of a Time Condition and restore to its original destination.

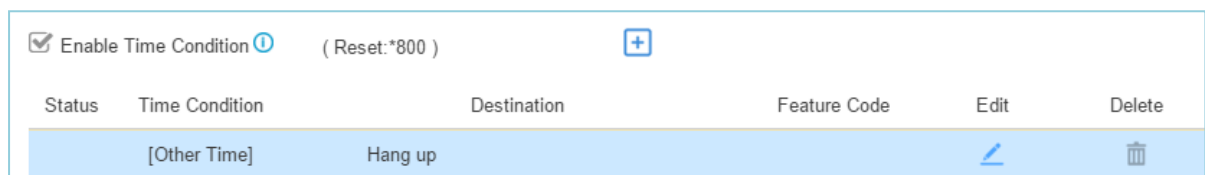

Figure 6-2 Time Condition

6) Distinctive Ring Tone

The system supports mapping to custom ring tone files. For example, if you configure the distinctive ringing for custom ring tone to "Family", the ring tone will be played if the phone receives the incoming call.

7) Fax Detection

Decide if you want to enable Fax Detection.

- If disabled, the system will not detect fax tone nor will it send fax tone.
- If enabled, the system will send the fax to Fax Destination if a fax tone is detected.

Fax Destination

Sets the destination where to send the fax to. You can set it to:

- Extension: send the fax to the designated extension. If it is a FXS extension, the fax will be

sent to the FXS port (fax machine).

- Fax To Email: sent the fax as an email attachment to the designated email address, which could be associated to an extension or a custom one.





Note:

Please make sure the sender email address is correctly configured in “System > Email”.

Outbound Routes

An outbound route works like a traffic cop giving directions to road users to use a predefined route to reach a predefined destination. Outbound routes are used to specify what numbers are allowed to go out a particular route. When a call is placed, the actual number dialed by the user is compared with the dial patterns in each route (from highest to lowest priority) until a match is found. If no match is found, the call fails. If the number dialed matches a pattern in more than one route, only the rules with the highest priority in the route are used.

Note:

- Yeastar S-Series compares the number with the pattern that you have defined in your route 1. If matches, it will initiate the call using the selected trunks. If it does not, it will compare the number with the pattern you have defined in route 2 and so on. The outbound route which is in a higher position will be matched firstly.
- Adjust the outbound route sequence by clicking these buttons     .

Go to **Settings > PBX > Call Control > Outbound Routes** to edit outbound routes. Please check the outbound route configuration parameters below.

1) Route Name

Give this outbound route a brief name to help you identify it.

2) Dial Patterns

Outbound calls that match this dial pattern will use this outbound route.

Table 6-2 Dial Patterns Description

Patterns	
X	Refers to any digit between 0 and 9
Z	Refers to any digit between 1 and 9
N	Refers to any digit between 2 and 9
[###]	Refers to any digit in the brackets, example [123] is 1 or 2 or 3. Note that multiple numbers can be separated by commas and ranges of numbers can be specified with a dash ([1.3.6-8]) would match the numbers 1,3,6,7 and 8.
. (dot)	Wildcard. Match any number of anything.
!	Used to initiate call processing as soon as it can be determined that no other

	matches are possible.
Strip	
Allow the users to specify the number of digits that will be stripped from the front of the phone number before the call is placed. For example, if users must press 0 before dialing a phone number, one digit should be stripped from the dial string before the call is placed.	
Prepend	
Digits to prepend to a successful match. If the dialed number matches the patterns, then this will be prepended before sending to the trunks. For example if a trunk requires 10-digit dialing, but users are more comfortable with 7-digit dialing, this field could be used to prepend a 3-digit area code to all 7-digit phone numbers before the calls are placed. When using analog trunks, a “w” character may also be prepended to provide a slight delay before dialing.	

3) Member Trunks

Select which trunks will be used in this route.

Member Trunks ⓘ:

Available		Selected
FXO2-3 (FXO)	>> > < <<	BRI2-1 (BRI)
FXO2-4 (FXO)		BRI2-2 (BRI)
GSM1-1 (GSM)		
SPX168 (IAX-P2P)		
SPS154 (SIP-P2P)		

Figure 6-3 Member Trunks

4) Member Extensions

Select extensions that will be permitted to use this outbound route.

Member Extensions ⓘ:

Available		Selected
504 - 504	>> > < <<	
505 - 505		
506 - 506		
507 - 507		
508 - 508		
509 - 509		

Figure 6-4 Member Extensions

5) Password

You can prompt users for a password before allowing calls to progress. The options are:

- None
- PIN List: select a list of PIN
- Password: enter a single password which will be needed when dialing through this outbound route

6) Rrmemory Hunt

Round robin with memory, remembers which trunk was used last time, and then use the next available trunk to call out.

7) Time Condition

This defines the time conditions to use this outbound route.

Auto CLIP Routes

The system automatically stores information about outgoing calls to the AutoCLIP routing table. When a person calls back the call is routed directly to the original number.

Go to **Settings > PBX > Call Control > Auto CLIP Routes** to configure Auto CLIP:

[View AutoCLIP List](#)

Record Keep Time ⓘ: 8 hours ▼

Match Outgoing Trunk ⓘ

Member Trunks ⓘ:

Available		Selected
FXO1-1 (FXO)	⬆	
FXO1-2 (FXO)	⬆	
GSM1-3 (GSM)	⬆	
FXO2-1 (FXO)	⬆	
FXO2-2 (FXO)	⬆	
FXO2-7 (FXO)	⬆	
FXO2-8 (FXO)	⬆	
...	⬆	

Save Cancel

Figure 6-5 Auto CLIP Route

- **Record Keep Time:** set the time duration for which records should be kept in the AutoCLIP List. Default is 8 hours.

- **Match Outgoing Trunk:** if enabled, only the incoming call that came to the PBX through the same trunk which made the call will be match against the AutoCLIP List.
- **Member Trunks:** choose the trunks, AutoCLIP Route will apply to the selected trunks.

Click [View AutoCLIP List](#) to view the records. In the AutoCLIP List you can see the record of the unconnected call.

AutoCLIP List				
<input type="button" value="Delete"/>				
<input type="checkbox"/>	Extension Number	Called Number	Expires in(hh:mm)	Delete
	500	284288432	5:09	

Figure 6-6 Auto CLIP List

As the above figure shows, when the user (284288432) has a missed call and returns the call, he will be directly forwarded to extension 500 as shown in the AutoCLIP List.

Time Conditions

On Time Condition page, you can create time groups. A time group is a list of times against which incoming or outgoing calls are checked. The rules specify a time range, by the time, day of the week, day of the month, and month of the year. Time conditions can be assigned to an inbound route, which control the destination of a call based on the time. Time conditions can also be assigned to an outbound route in order to limit the use of that route.

Add Time Condition

Go to **Settings > PBX > Call Control > Time Conditions**, click to add time condition.

Add Time Condition					
Name ⓘ:	<input type="text"/>				
Time:	<input type="text" value="00"/>	:	<input type="text" value="00"/>	-	<input type="text" value="00"/> : <input type="text" value="00"/> <input type="button" value="+"/>
Days of Week:	<input type="checkbox"/> All	<input type="checkbox"/> Sunday	<input type="checkbox"/> Monday	<input type="checkbox"/> Tuesday	<input type="checkbox"/> Wednesday
		<input type="checkbox"/> Thursday	<input type="checkbox"/> Friday	<input type="checkbox"/> Saturday	
Advanced Options ⓘ:	<input type="checkbox"/>				

Figure 6-7 Add Time Condition

- **Name:** give this Time Condition a brief name to help you identify it.
- **Time:** this is where you will define a time range. You can define multiple ranges in the same time group by clicking .

- **Days of Week:** select a week day, month day, and/or month range in which you want this time range to apply.
- **Advanced Options:** this option is disabled by default. If it is enabled, you need to set the month and the day of the month. If it is disabled, it means that the time range defined above will apply to every day of the month, every month of the year.

Add a Holiday

After you have defined your office time conditions, you may need to create a holiday time groups. For example, you want to create a Holiday for Chinese National Day, from October 1st to October 5th.

Click [Add Holiday](#) to add a holiday.

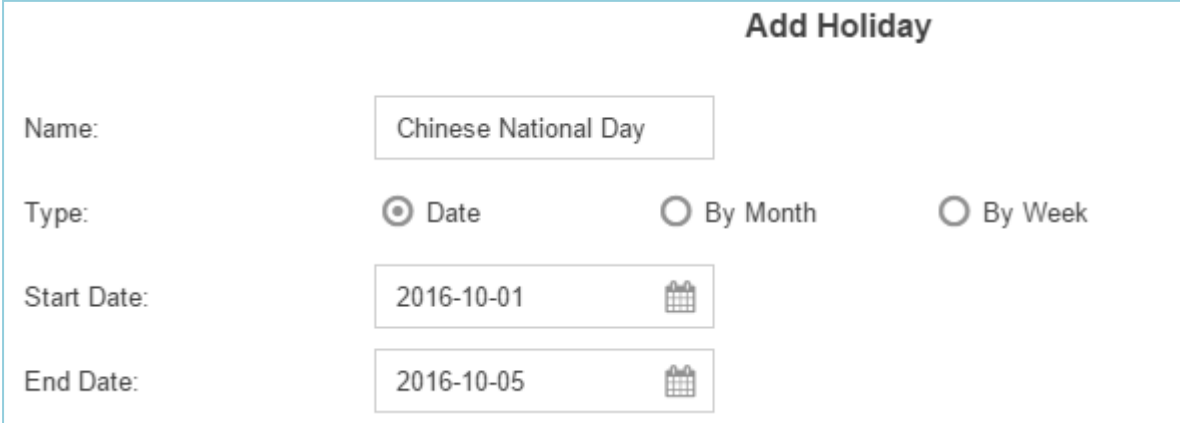

The screenshot shows a form titled "Add Holiday" with the following fields and values:

- Name:** Chinese National Day
- Type:** Date, By Month, By Week
- Start Date:** 2016-10-01 (with a calendar icon)
- End Date:** 2016-10-05 (with a calendar icon)

Figure 6-8 Add Holiday

Assigning Time Conditions to Inbound Routes

The created Time Conditions will become available for selection in the Inbound Routes.

Assigning Time Conditions to Outbound Routes

You can also assign Time Conditions to outbound routes, which may help you to control the route can be used. For example, you can limit the users to make outbound calls when your office is closed.

Call Features





This chapter explains various call features on Yeastar S-Series.

- [IVR](#)
- [Ring Group](#)
- [Queue](#)
- [Conference](#)
- [Pickup Group](#)
- [Speed Dial](#)
- [Callback](#)
- [DISA](#)
- [Blacklist/Whitelist](#)
- [Pin List](#)
- [Paging/Intercom](#)
- [SMS](#)

IVR

Like most organizations, where possible, we would like to route incoming calls an Auto Attendant. You can create one or more IVR (Auto Attendant) on S-Series to achieve it. When calls are routed to an IVR, S-Series will play a recording prompting them what options the callers can enter such as “Welcome to XX, press 1 for Sales and press 2 for Technical Support”.

Go to **Settings > PBX > Call Features > IVR** to configure IVR.

- Click  to add a new IVR.
- Click  to delete the selected IVR.
- Click  to edit one IVR.
- Click  to delete one IVR.

Please check the IVR configuration parameters below.

Table 7-1 IVR Configuration Parameters



Basic Settings	
Number	Yeastar S-Series treats IVR as an extension; you can dial this extension number to reach the IVR from internal extensions.
Name	Give this IVR a brief name to help you identify it.
Prompt	The prompt that will be played when the caller reaches this IVR.
Prompt Repeat Count	The number of times that the selected IVR prompt will be played.

Response Timeout	The number of seconds to wait for a digit input after prompt.
Digit Timeout	How long (in seconds) we wait for the caller to enter an option on their phone keypad before we consider it timed out and it follows the Timeout Destination as defined below.
Dial Extension	If this option is enabled, the callers can enter a user's extension number when entering the IVR to go direct to the users.
Dial Outbound Routes	Allow the caller to dial through outbound routes.
Keypress Events	
Key Press Event	
0	Select the destination for each key pressing: digits 0-9, "#", "*", Timeout and Invalid. When the callers press the corresponding key, the call will be routed to:
1	
2	
3	
4	
5	
6	
7	
8	
9	
#	
*	
Timeout	
Invalid	
	<ul style="list-style-type: none"> • Extension • Voicemail • Ring Group • IVR • Conference Room • Queues • Faxes • Dial by Name • Hangup

Ring Group

A ring group helps you to ring a group of extensions in a variety of ring strategies. For example, you could define all the technical support guys' extensions in a ring group and ring the support guys one by one.

Go to **Settings > PBX > Call Features > Ring Group** to configure ring groups.

- Click **Add** to add a new ring group.
- Click **Delete** to delete the selected ring groups.
- Click  to edit one ring group.
- Click  to delete one ring group.

Please check the ring group configuration parameters below.

Table 7-2 Ring Group Configuration Parameters-General Settings



Option	Description
--------	-------------

Number	The extension number dialed to reach this ring group.
Name	Give this ring group a brief name to help you identify it.
Ring Strategy	Select an appropriate ring strategy for this ring group. <ul style="list-style-type: none"> Ring All Simultaneously: ring all the available extensions simultaneously. Ring Sequentially: ring each extension in the group one at a time.
Seconds to ring each member	Set the number of seconds to ring a single extension before moving to the next one.
Members	Choose the member of this ring group
Destination If No Answer	Choose the failover destination.

Queue

Queues are designed to receive calls in a call center. A queue is like a virtual waiting room, in which callers wait in line to talk with the available agent. Once the caller called in S-Series and reached the queue, he/she will hear hold music and prompts, while the queue sends out the call to the logged-in and available agents. A number of configuration options on the queue help you to control how the incoming calls are routed to the agents and what callers hear and do while waiting in the line.

Go to **Settings > PBX > Call Features > Queue** to configure queue.

- Click **Add** to add a new queue.
- Click **Delete** to delete the selected queues.
- Click  to edit one queue.
- Click  to delete one queue.

Please check the queue configuration parameters below.

1) Basic Settings

Table 7-3 Queue Configuration Parameters - Basic Settings

Basic Settings	
Number	Use this number to dial into the queue, or transfer callers to this number to put them into the queue.
Name	Give this queue a brief name to help you identify it.
Password	You can require agents to enter a password before they can login to this queue.
Ring Strategy	This option sets the Ringing Strategy for this Queue. The options are: <ul style="list-style-type: none"> Ring All: ring all available agents simultaneously until one answer. Least Recent: ring the agent which was least recently called. Fewest Calls: ring the agent with the fewest completed calls.

	<ul style="list-style-type: none"> • Random: ring a random agent. • Rememory: Round Robin with Memory, remembers where it left off in the last ring pass. • Linear: rings agents in the order specified in the configuration file.
Failover Destination	Set the failover destination.
Static Agents	<p>This selection shows all users. Selecting a user here makes them a dynamic agent of the current queue. The dynamic agent is allowed to log in and log out the queue at any time.</p> <ul style="list-style-type: none"> • Dial "Queue number" + "*" to log in the queue. • Dial "Queue number" + "***" to log out the queue.
Agent Timeout	The number of seconds an agent's phone can ring before we consider it a timeout. If you wish to customize, enter the value in the text box directly.
Agent Announcement	Announcement played to the Agent prior to bridging in the caller.
Wrap-up Time	How many seconds after the completion of a call an Agent will have before the Queue can ring them with a new call .If you wish to customize, enter the value in the text box directly. Input 0 for no delay.
Ring In Use	If set to "no", unchecked, the queue will avoid sending calls to members whose device are known to be "in use".
Retry	The number of seconds to wait before trying all the phones again. If you wish to customize, enter the value in the text box directly.

2) Caller Experience Settings

Table 7-4 Queue Configuration Parameters – Caller Experience Settings





Caller Settings	
Music On Hold	Select the "Music on Hold" playlist for this Queue.
Caller Max Wait Time	Select the maximum number of seconds a caller can wait in a queue before being pulled out. If you wish to customize, enter the value in the text box directly. Input 0 for unlimited.
Leave When Empty	If enabled, callers already on hold will be forced out of a queue when no agents available.
Join Empty	If enabled, callers can join a queue that has no agents.
Join Announcement	Announcement played to callers once prior to joining the queue.
Caller Position Announcements	
Announce Position	Announce position of caller in the queue.
Announce Hold Time	Enabling this option causes PBX to announce the hold time to the caller periodically based on the frequency timer. Either yes or no; hold time will be announced after one minute.
Frequency	How often to announce queue position and estimated hold time.
Periodic Announcements	
Prompt	Select a prompt file to play periodically.

Frequency	How often to play the periodic announcements.
Events	
Once the events settings are configured, the callers are able to press the key to enter the destination you set. Usually, a prompt should be set on Periodic Announcements to guide the callers to press the key.	

Conference

Conference Calls increase employee efficiency and productivity, and provide a more cost-effective way to hold meetings. Conference agents can dial * to access to the settings options and the admin can kick the last user out and can lock the conference room.

Go to **Settings > PBX > Call Features > Conference** to configure conferences.

- Click  to add a new conference.
- Click  to delete the selected conferences.
- Click  to edit one conference.
- Click  to delete one conference.

Please check the conference configuration parameters below.

Table 7-5 Conference Configuration Parameters

Options	Description
Number	Use this number to dial into the conference room.
Name	Give the conference a brief name to help you identify it.
Administrator	Admin can kick the users out and lock the conference. Also you can set none.
PIN#	You can require callers to enter a password before they can enter this conference. This setting is optional.

Join a Conference Room

Users on S-Series could dial the conference extension to join the conference room. If a password is set for the conference, users would be prompted to enter a PIN.

How to join the conference room if I am calling from outside (i.e. calling from my mobile phone)?

In this case, an inbound route for conferences should be set on S-Series. A trunk should be selected in the inbound route and destination should be set to a conference room. When the outside users dial in the trunk number, the call will be routed to the conference room.

Manage the Conference

During the conference call, the users could manage the conference by pressing * key on their

phones to access voice menu for conference room.
Please check the options for the voice menu.



Table 7-6 Conference Voice Menu

Conference Administrator IVR Menu	
1	Mute/ un-mute yourself.
2	Lock /unlock the conference.
3	Eject the last user.
4	Decrease the conference volume.
6	Increase the conference volume.
7	Decrease your volume.
8	Exit the IVR menu.
9	Increase your volume.
Conference Users IVR Menu	
1	Mute/ un-mute yourself.
4	Decrease the conference volume.
6	Increase the conference volume.
7	Decrease your volume.
8	Exit the IVR menu.
9	Increase your volume.

Pickup Group

Call pickup allows one to answer someone else's call. You can add pickup group. The default call pickup for Group Call Pickup is *4. It allows you to pick up a call from a ringing phone which is in the same group as you.

Go to **Settings > PBX > Call Features > Pickup Group** to add pickup group.

- Click **Add** to add a new pickup group.
- Click **Delete** to delete the selected pickup groups.
- Click  to edit one pickup group.
- Click  to delete one pickup group.

Add Pickup Group

Name

Member

Available

500 - 500
501 - 501
502 - 502
503 - 503
504 - 504
505 - 505

Selected

>>
>
<
<<

Save Cancel

Figure 7-1 Add Pickup Group

Speed Dial

Sometimes you may just need to call someone quickly without having to look up his/her phone number. You can by simply define a shortcut number. Speed Dial feature is available on Yeastar S-Series that allowing you to place a call by pressing a reduced number of keys.

1) Add Speed Dial

Click **Add** to add a speed dial.

Add Speed Dial

Speed Dial Code:

Phone Number:

Save Cancel

Figure 7-2 Add Speed Dial

- **Speed Dial Code:** enter the speed dial code.
- **Phone Number:** enter the number you want to call.

2) Import Speed Dial

Click **Import**, you will see a dialog window shown as below.

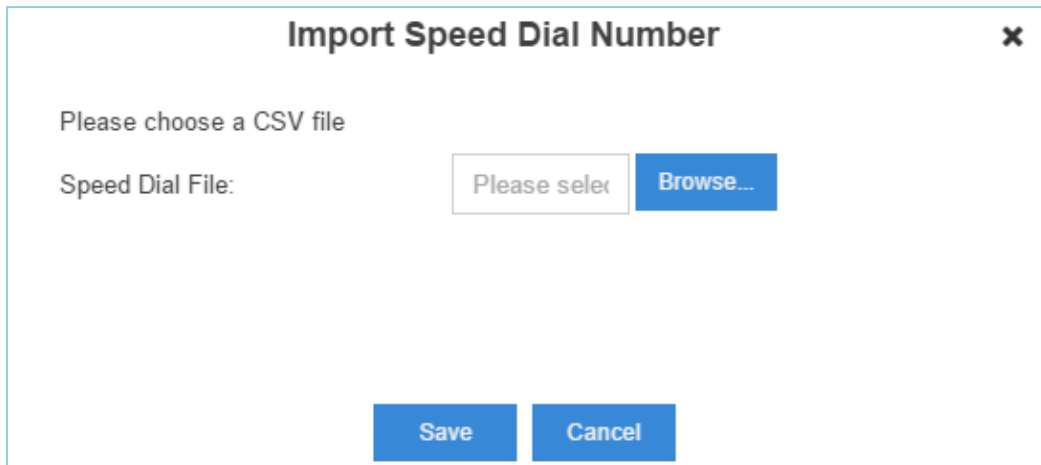

The dialog window titled "Import Speed Dial Number" contains the following elements:

- A close button (X) in the top right corner.
- Text: "Please choose a CSV file"
- Text: "Speed Dial File:" followed by a text input field containing "Please select" and a blue "Browse..." button.
- At the bottom, there are two blue buttons: "Save" and "Cancel".

Figure 7-3 Import Speed Dial Number

Click **Browse** and select the file to start uploading. The file must be a .csv file. Check the sample file below. You can export a speed dial file from S-Series and use it as a sample to start with.

	A	B	C	D	E	F
1	Speed Dial Code	Phone Number				
2		1	3545454			
3		2	4645745656			
4		3	456576666			
5		4	67585666			
6		5	24645555			
7						

Figure 7-4 Speed Dial File

The sample csv file will result in the following speed dial in Yeastar S-Series.

<input type="checkbox"/>	Speed Dial Code	Phone Number	Edit	Delete
<input type="checkbox"/>	1	3545454		
<input type="checkbox"/>	2	4645745656		
<input type="checkbox"/>	3	456576666		
<input type="checkbox"/>	4	67585666		
<input type="checkbox"/>	5	24645555		

Figure 7-5 Speed Dial Codes

3) Export Speed Dial

Select the checkbox of the speed dial, click **Export**, the selected speed dial will be exported to your local PC.

<input type="checkbox"/>	Speed Dial Code	Phone Number	Edit	Delete
<input checked="" type="checkbox"/>	1	218737823882		
<input checked="" type="checkbox"/>	2	1237823147831		
<input checked="" type="checkbox"/>	3	7834273928838833		
<input type="checkbox"/>	4	2347187744444		

Figure 7-6 Export Speed Dial

Callback

Callback feature allows callers to hang up and get called back to Yeastar S-Series Callback feature could reduce the cost for the users who work out of the office using their own mobile phones.

Go to **Settings > PBX > Call Features > Callback** to configure Callback.

- Click **Add** to add a new callback.
- Click **Delete** to delete the selected callbacks.
- Click to edit one callback.
- Click to delete one callback.

To use callback feature, you need to select callback as destination on the inbound route.

Please check the callback configuration parameters below.

Note: you don't need to configure "Strip" and "Prepend" options if the trunk supports call back with the caller ID directly.

Figure 7-7 Add Callback

Table 7-7 Call Back Configuration Parameters

Option	Description
Name	Give this Callback a brief name to help you identify it.
Callback Through	Choose a trunk, the call will be called back through the selected trunk.
Delay Before Callback	Set the number of seconds before calling back a caller.
Strip	Defines how many digits will be stripped from the call in number before the callback is placed.
Prepend	Defines digits added before a callback number before the callback is placed.
Destination	The destination which the callback will direct the caller to.

DISA

DISA (Direct Inward System Access) allows someone calling in from outside Yeastar S-Series to obtain an “internal” system dial tone and make calls as if they were using one of the extensions of S-Series.

To use DISA, a user calls a DISA number, which invokes the DISA application. The DISA application in turn requires the user to enter a PIN number, followed by the pound key (#). If the PIN number is correct, the user will hear dial tone on which a call may be placed.

Please check the callback configuration parameters below.

Figure 7-8 Add DISA

Table 7-8 DISA Configuration Parameters

Option	Description
Name	Give this DISA a brief name to help you identify it.
Password	The password for this DISA.
Response Timeout	The maximum amount of time the system will wait before hanging up the call if the user has dialed an incomplete or invalid number. The default value is 10s.
Digit Timeout	The maximum amount of time permitted between each digit when the user is dialing an extension number. The default value is: 5s.
Member Outbound Routes	Defines the outbound routes that can be accessed from this DISA.

Blacklist/Whitelist

Blacklist is used to block an incoming/outgoing call. If the number of incoming or outgoing call is listed in the number blacklist, the caller will hear the following prompt: “The number you have dialed is not in service. Please check the number and try again”. The system will then disconnect the call. Whitelist is used to allow incoming/outgoing numbers.

The system supports to block or allow 3 types of numbers:

- 4) **Inbound:** the number would be disallowed or allowed to call in the system.
- 5) **Outbound:** users are disallowed or allowed to call the number out from the system.
- 6) **Both:** both inbound and outbound calls are disallowed or allowed.

1) Add Blacklist/Whitelist

Select Blacklist or Whitelist tag, click [Add](#) to add a number to Blacklist or Whitelist.

Figure 7-9 Add Blacklist

- 7) **Name:** give a name for the blacklist/whitelist.
- 8) **Number:** enter the numbers, one number per row.
- 9) **Type:** choose the type.

2) Import Blacklist/Whitelist

Click **Import**, you will see a dialog window shown as below.

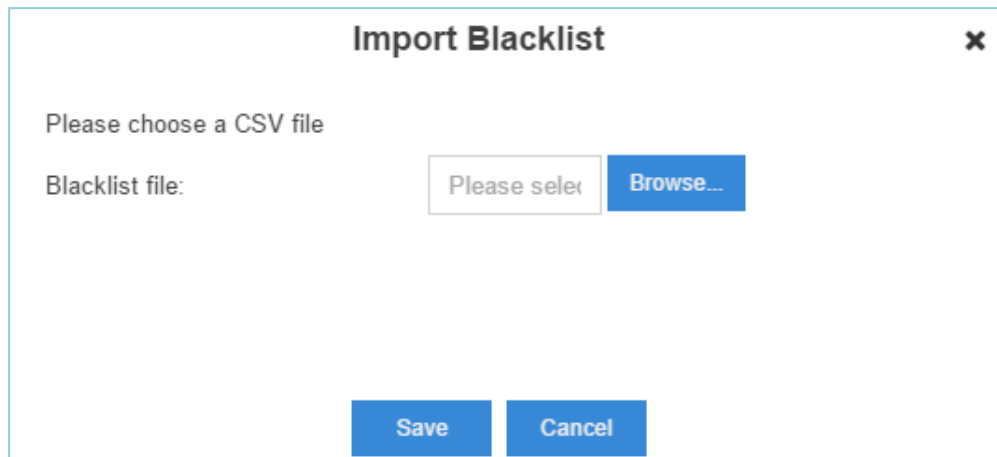

Figure 7-10 Import Blacklist

Click **Browse** and select the file to start uploading. The file must be a .csv file. Open the file with notepad, check the sample below. You can export a blacklist/whitelist file from S-Series and use it as a sample to start with.

```

1 Name,Number,Type
2 international,18288383,73829911,outbound
3 ads,28192828,83829920,88287373,inbound
4 blacklist,18283883,89388383,both
5

```

Figure 7-11 Blacklist/Whitelist File

The sample csv file will result in the following speed dial in Yeastar S-Series.

<input type="checkbox"/>	Name	Number	Type	Edit	Delete
<input type="checkbox"/>	international	18288383,73829911	Outbound		
<input type="checkbox"/>	ads	28192828,83829920,8828...	Inbound		
<input type="checkbox"/>	blacklist	18283883,89388383	Both		

Figure 7-12 Blacklist/Whitelist

10) Export Blacklist/Whitelist

Select the checkbox of the blacklist/whitelist, click **Export**, the selected blacklist/whitelist will be exported to your local PC.

Pin List

PIN List is used to manage lists of PINs (numerical passwords) that can be used to access restricted

features such as outbound routes. The PIN can also be presented in the CDR record.

Go to **Settings > PBX > Call Features > Pin List** and click **Add** to add Pin list.

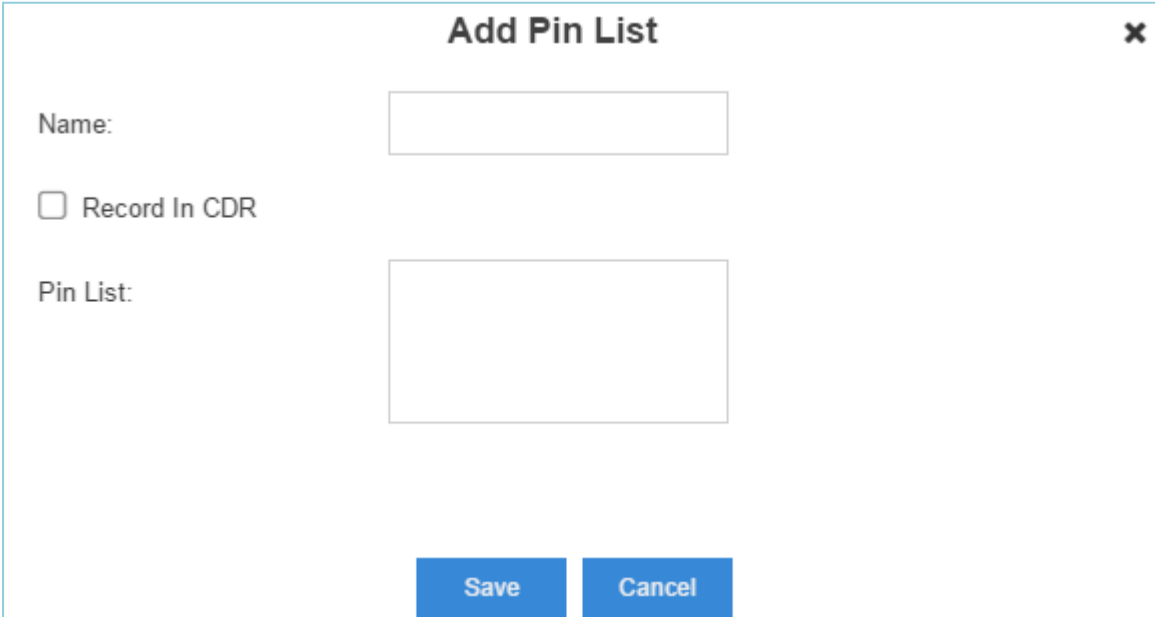

The screenshot shows a modal dialog box titled "Add Pin List" with a close button (X) in the top right corner. The dialog contains the following elements:

- A label "Name:" followed by a text input field.
- A checkbox labeled "Record In CDR" which is currently unchecked.
- A label "Pin List:" followed by a larger text input field.
- At the bottom, there are two buttons: "Save" and "Cancel".

Figure 7-13 Add PIN List

Linking a PIN List to Outbound Routes/DISA

After creating PIN lists, you can link the PIN lists to Outbound Routes or DISA. On outbound route/DISA edit page, you can select the PIN list from the **Password** drop-down menu.

Paging/Intercom

Intercom is a feature that allows you to make an announcement to one extension via a phone speaker. The called party does not need to pick up the handset. It can be achieved by pressing the feature code on your phone and it is a two-way audio call.

The default Intercom feature code is *5. To make an announcement to a specific extension, you need to dial *5+ extension number on your phone. For example, make an announcement to extension 500, you need to dial *5500, then the extension 500 will be automatically picked up.

Paging is used to make an announcement over the speakerphone to a phone or group of phones. Targeted phones will not ring, but instead answer immediately into speakerphone mode. Paging is typically one way for announcements only, but you can set the paging group as a duplex mode to allow all users in the group to talk and be heard by all.

Go to **Settings > PBX > Call Features > Paging/Intercom**, click **Add** to add a paging group.

Figure 7-14 Add Paging Group

- 11) **Number**: the extension number dialed to reach this Paging Group.
- 12) **Name**: give this Paging Group a brief name to help you identify it.
- 13) **Type**: select the mode of paging group.
 - a) 1-Way Paging: typically one way for announcement only.
 - b) 2-Way Paging: make paging duplex, allowing all users in the group to talk and be heard by all.
- 14) **Member**: select the members of the group.

SMS

Yeastar S-Series supports **SMS to Email** and **Email to SMS** features. To use these two features, you must do the following:

- 15) Install **GSM/CDMA/3G** module on the device.
- 16) Insert **SIM card** on the GSM/CDMA/3G module.
- 17) Check the trunk status and make sure that the GSM/CDMA/3G trunk is ready to be used.
- 18) Set an email address for the system (Settings > System > Email).

SMS to Email

SMS to Email is a feature that allows users' email to receive the SMS of a GSM network. The SMS sent to the GSM/CDMA/3G ports will be received first by application of Yeastar system and then forwarded to the pre-configured email address (the email set in Settings > System > Email). Thus, users can receive the SMS through email.





Enable SMS To Email				
Cellular Trunk Name	Cellular Trunk Port	Email List	Edit	Delete
GSM1-3	Span1_Port3			

Figure 7-15 Enable SMS to Email

Choose a GSM trunk and click  , you will see the dialog appear as below. Click  to add email address then click **Ensure** .

Edit SMS To Email (GSM1-1)

Trunk Name:

Email List: 





Email Address	Edit	Delete
501 - 501 (wujinige)	Ensure Cancel	 
505 - 505 (765072518@qq.com)		 

Figure 7-16 Edit SMS To Email

When you send a SMS from your mobile to the GSM trunk number, the SMS message will be delivered to the email addresses.

Email to SMS

Email to SMS is a feature that allows users to send SMS to mobile phone number via email. When users would like to send a SMS, they just need to send an email to the Yeastar system's email address, with the destination mobile phone number as the email subject. The system will then receive the email and forward the email to the GSM/CDMA/3G port, so that the email can be sent out through SMS to expected destinations.

Enable Email To SMS

Country Code:

Email Checking Interval(s) :

Access Code :

Figure 7-17 Enable Email to SMS

The system supports 4 email subjects.

1) **Email Subject:** Destination Phone Number

If you choose this format, you don't need to set access code.

2) **Email Subject:** port:Port Number-Destination Phone Number

If you choose this format, you don't need to set access code.

3) **Email Subject:** 500:Access Code-Destination Phone Number

4) **Email Subject:** 500:Access Code- port: Port Number-Destination Phone Number

Voice Prompts

In this chapter, we introduce how to manage voice on Yeastar S-Series, including the following sections:

- [Prompt Preference](#)
- [System Prompt](#)
- [Music on Hold](#)
- [Custom Prompts](#)

Prompt Preference

Select prompt files for the relevant options on this page.

Table 8-1 Prompt Preference Configuration Parameters

Option	Description
Music On Hold	The music to play when a call is being held.
Play Call Forwarding Prompt	If enabled, system will play a prompt before transferring the call. Otherwise, the call will be transferred directly without any prompt. It is enabled by default.
Music On Hold for Call Forwarding	This decides what to play when the caller is put on hold during call forwarding. The options are: <ul style="list-style-type: none"> • Music, which will be the same with the one selected in Music on Hold. • Ringing Tone The default is to play Music.
Invalid Phone Number Prompt	The prompt to play when the dialed phone number is invalid.
Busy Line Prompt	The prompt to play when the dialed phone number is busy.
Dial Failure Prompt	The prompt to play when a dial failed due to conjunction and lack of available trunks.

System Prompt

Yeastar S-Series ships with a US English prompt set by default. The system supports multiple languages. You could update the system prompt from the cloud server directly. Also, upload system prompt from local PC is supported.

Go to **Settings > PBX > Voice Prompt > System Prompt** to update the system prompt.

Upload System Prompts

Click [Browse](#) to select the system prompt file from local computer, then click [Upload](#) to start uploading.

Upload System Prompts

Please choose a file: [Browse...](#) [Upload](#)

Figure 8-1 Upload System Prompts

Download Online Prompt

Click **Download Online Prompt**, a dialog window appears as the following figure. All the available system prompts are listed on the window.



Download Online Prompt				
Language	Remote Version	Local Version	File Size	Options
Englist System Prompt	1.0.1	1.0.0	1661920	
Chinese System Prompt	1.0.1	0.0.0	2048952	

Figure 8-2 Download Online Prompt

Click  to download the latest prompts. The new downloaded system prompt will be displayed once installed successfully. You can select the prompt to apply in the S-Series system or delete it.

Music on Hold

Music on hold (MOH) is the business practice of playing recorded music to fill the silence that would be heard by callers who have been placed on hold. Users could configure Music on Hold Folder and upload music files to the system. The "default" Music on Hold Playlist includes 3 music files for users to use.

Go to **Settings > PBX > Voice Prompts > Music on Hold**.

1) Create New Playlist

Click **Create New Playlist** to create a new playlist.

Add Playlist ✕

Name :

Play Sort :

Figure 8-3 Add Playlist

- **Name:** give this playlist a name to help you identify it.
- **Play Sort:** select the playing order of the playlist.

2) Upload New Music

Figure 8-4 Upload New Music

Choose MOH Playlist from the drop-down menu.

Click **Browse** to select music file from your local computer, click **Upload** to start uploading.

Custom Prompt

The default voice prompts and announcements in the system are suitable for almost every situation. However, you may want to use your own voice prompt to make it more meaningful and suitable for your case. In this case, you need to upload a custom prompt to the system or record a new prompt and apply it to the place you want to change.

Go to **Settings > PBX > Voice Prompts > Custom Prompts** to record and upload custom prompts.

1) Upload Custom Prompt

Click **Upload**, the following dialog window appears. Click **Browse...** to choose a music file from your computer. Click **Upload** to start uploading.

Figure 8-5 Upload a Prompt

2) Record Custom Prompt

Click **Record New**, the following dialog window shows. Specify the name and choose an extension to make the record.

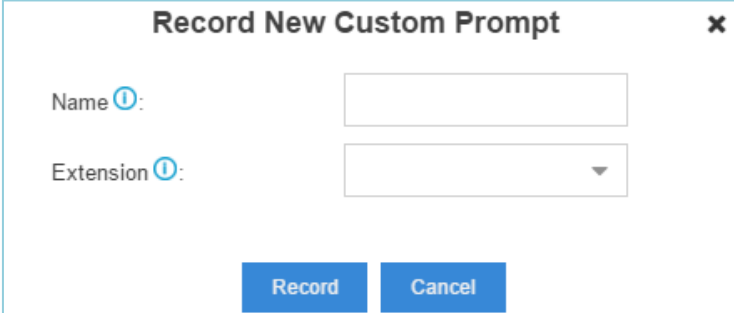

The image shows a dialog box titled "Record New Custom Prompt" with a close button (X) in the top right corner. It contains two input fields: "Name" with a text box and "Extension" with a dropdown menu. At the bottom, there are two buttons: "Record" and "Cancel".

Figure 8-6 Record New Custom Prompt

Click **Record**, the selected extension will ring, pick up the call to start recording.

General

This chapter explains general settings in the system, which can be applied globally to Yeastar S-Series.

- Preference
- Feature Code
- Voicemail
- SIP
- IAX

Preference

Table 9-1 Preference Configuration Parameters

Option	Description
Max Call Duration	Select the absolute maximum number of seconds permitted for a call. If you wish to customize, enter the value in the text box directly. Input 0 disables the timeout.
Attended Transfer Caller ID	The Caller ID that will be displayed on the recipient's phone. For example, Phone A (transferee) calls Phone B (transfer), and Phone B transfers the call to Phone C (recipient). If set to Transfer, the Caller ID displayed will be Phone B's number; if set to Transferee, Phone A's number will be displayed.
Virtual Ring Back Tone	Once enabled, when the caller calls out with cellular trunks, the caller will hear the virtual ring back tone generated by the system before the callee answers the call.
Distinctive Caller ID	When the incoming call is routed from Ring Group, Queue or IVR, the Caller ID would display where it comes from.
FXO Mode	Select a mode to set the On Hook Speed, Ringer Impedance, Ringer Threshold, Current Limiting, TIP/RING voltage, adjustment, Minimum Operational Loop Current, and AC Impedance as predefined for your country's analog line characteristics. The default setting is FCC for USA.
Tone Region	Select your country or nearest neighboring country to enable the default dial tone, busy tone, and ring tone for your region.
Extension Preferences	
User Extensions	Specify the user extension range. The default range is 500-599.
Ring Group Extensions	Specify the Ring Group extension range. The default range is 620-629.
Paging Group Extensions	Specify the Paging Group extension range. The default range is 630-639.
Conference Extensions	Specify the Conference extension range. The default range is 640-649.

IVR Extensions	Specify the IVR extension range. The default range is 650-659.
Queue Extensions	Specify the Queue extension range. The default range is 660-669.

Feature Code

Feature Codes are used to enable and disable certain features available in the system. The S-Series local users can dial feature codes on their phones to use a particular feature.

The default feature codes can be checked and changed via **Settings > PBX > General > Feature Code**.

Table 9-2 Feature Code

Feature Code	
Feature Code Digits Timeout	The timeout to input next digit (in milliseconds). The default is 4000.
Recording	
One Touch Record	The feature code that is used to start or stop call recording. The default feature code is *1.
Voicemail	
Check Voicemail	The feature code that is used to check voicemail. The system will prompt you for password. The default feature code is *2.
Voicemail for Extension	You can leave a voicemail to other extensions by dialing feature code on their phone or forward an incoming call to an extension's voicemail directly. The default feature code is #. For example, dial "#501" to leave a message for Ext. 501.
Voicemail Main Menu	The feature code that is used to access voicemail main menu. The default feature code is *02.
Transfer	
Blind Transfer	Dial this feature code and an extension number to blind transfer the call. The default feature code is *03.
Attended Transfer	Dial this feature code and an extension number to transfer the call. Hang up after contacting the destination. The default feature code is *3.
Attended Transfer Timeout	The timeout to transfer a call, in seconds. The default is 15 seconds.
Call Pickup	
Call Pickup	This feature code allows you to answer another ringing phone that is in the same pickup group. The default feature code is *4.
Extension Pickup	Dial this feature code and an extension number to pick up a call

	that is ringing at the extension. The default feature code is *04.
Intercom	
Intercom	Dial this feature code and an extension number to page that extension. The default feature code is *5.
Call Parking	
Call Parking	Dial this feature code to put a call on hold and park the call at an extension number directed by the system. Any other phone can dial this extension number to resume the conversation. The default feature code is *6.
Directed Call Parking	Dial this feature code and an extension number to park the call at that extension. Any other phone can dial this extension number to resume the conversation. The default feature code is *6. Note: if the directed extension number is occupied, the call parking will fail.
Parking Extension Range	A range of extensions where the call will be parked.
Parking Timeout	This defines the number of seconds that a call can be parked before it is recalled by an extension.
Call Forwarding	
Reset to Defaults	Dial this feature code to restore call forwarding to the following default settings: <ul style="list-style-type: none"> • Always Forward: disabled • Busy Forward to Voicemail: enabled • No Answer Forward to Voicemail: enabled • Do Not Disturb: disabled. The default feature code is *70.
Enable Forward All Calls	Dial this feature code to forward all calls to voicemail or a designated number. For example: dial *71 to forward all calls to voicemail, and dial *71500 to forward all calls to number 500 (this number does not include prefix, if you are required to dial with prefix, you need to configure it in Call Forwarding in Edit Extension window).
Disable Forward All Calls	Dial this feature code to disable forwarding of all calls. The default feature code is *071.
Enable Forward When Busy	Dial this feature code to forward calls to voicemail or a designated number when busy. For example: dial *72 to forward calls to voicemail when busy, and dial *72500 to forward all calls to number 500 when busy (this number does not include prefix, if you are required to dial with prefix, you need to configure it in Call Forwarding in Edit Extension window). The default feature code is *72.
Disable Forward When Busy	Dial this feature code to disable when busy call forwarding.

	The default feature code is *072.
Enable Forward No Answer	Dial this feature code to forward calls to voicemail or a designated number when no answer. For example: dial *73 to forward calls to voicemail when no answer, and dial *73500 to forward all calls to number 500 when no answer (this number does not include prefix, if you are required to dial with prefix, you need to configure it in Call Forwarding in Edit Extension window). The default feature code is *73.
Disable Forward No Answer	Dial this feature code to disable no answer call forwarding. The default feature code is *073.
Call Monitor	
Listen	Dial this feature code and the monitored extension number to initiate Listen monitoring. In this mode, the monitor can only listen to the call but can't talk. The default feature code is *90. Note: to monitor an extension, you need to configure the Monitor Settings for this extension first.
Whisper	Dial this feature code and the monitored extension number to initiate Whisper monitoring. In this mode, the monitor can listen to and talk with the monitored extension without being heard by the other party. The default feature code is *91. Note: to monitor an extension, you need to configure the Monitor Settings for this extension first.
Barge-in	Dial this feature code and the monitored extension number to initiate Barge-in monitoring. In this mode, the monitor can listen to and talk with both parties. The default feature code is *92. Note: to monitor an extension, you need to configure the Monitor Settings for this extension first.
DND	
Enable Do Not Disturb	Dial this feature code to put the extension in Do Not Disturb state. The default feature code is *74.
Disable Do Not Disturb	Dial this feature code to take the extension out of Do Not Disturb state. The default feature code is *074.

Voicemail

The configurations of voicemail can be globally set up and managed on the Voicemail page. Go to **Settings > PBX > General > Voicemail**, you can configure the Message Options, Greeting Options and Playback Options.

Table 9-3 Voicemail Configuration Parameters

Message Options	
Max Messages per Folder	This sets the maximum number of messages that can be stored in a single folder of voicemail.
Max Message Time	This sets the maximum length of a single voicemail message (in seconds).
Min Message Time	This sets the minimum length of a single voicemail message (in seconds). Messages below this threshold will be automatically deleted.
Ask Caller to Dial 5	If this option is enabled, the caller will be prompted to press 5 before leaving a message.
Operator Breakout from Voicemail	If this option is set, the caller can jump out of the voicemail and go to the pre-configured destination by dialing 0.
Destination	This sets the breakout destination.
Greeting Options	
Busy Prompt	Greeting played when the extension is busy.
Unavailable Prompt	Greeting played when the extension is unavailable.
Leave a Message Prompt	Greeting played when dial 5.
Playback Options	
Announce Message Caller ID	If this option is enabled, the caller ID of the party that left the message will be announced before the voicemail message begins playing.
Announce Message Duration	If this option is enabled, the duration of the message in minutes will be announced before the voicemail message begins playing.
Announce Message Arrival Time	If this option is enabled, the arrival time of the message will be played back before the voicemail message begins playing.
Allow Users to Review Messages	Allow the callers to review their recorded messages before sending them to the voicemail box.

Voicemail to Email Template

You can customize the Voicemail Email contents by clicking [Voicemail To Email Template Settings](#).

Voicemail To Email Template Settings ✕

Template Variables:

TAB : `lt`
 RETURN : `\n`
 Recipient's firstname and lastname : `$(VM_NAME)`
 The duration of the voicemail message : `$(VM_DUR)`
 The recipient's extension : `$(VM_MAILBOX)`
 The caller ID of the person who has left the message : `$(VM_CALLERID)`
 The message number in the mailbox : `$(VM_MSGNUM)`
 The date and time when the message was left : `$(VM_DATE)`

Subject:

Email Content:

Figure 9-1 Voicemail To Email Template Settings

SIP

Go to **Settings > PBX > General > SIP** to configure SIP settings. It is wise to leave the default setting as provided on this page. However, for a few fields, you need to change them to suit your situation.

General

Table 9-4 General Settings

UDP Port	UDP Port used for SIP registrations. The default is 5060.
TCP Port	TCP Port used for SIP registrations. The default is 5060.
RTP Port	RTP Port for transmitting data. The From-port should start from 10000. From-port and To-port should have a difference value between 100 and 10000. The default is 10000-12000.
Register Timers	
Max Registration/Subscription Time	Maximum duration (in seconds) of incoming registrations and subscriptions. The default is 3600 seconds.
Min Registration/Subscription Time	Minimum duration (in seconds) of incoming registration and subscriptions. The default is 60 seconds.
Qualify Frequency	How often to send SIP OPTIONS packet to SIP device to check if the device is up. The default is 30 per second.
Outbound SIP Registrations	
Register Attempts	The number of registration attempts before giving up (0 for no limit).
Default Incoming/Outgoing Registration Time	Default duration (in seconds) of incoming/outgoing registration. The default is 120 seconds.

Note: the actual duration needs to minus 10 seconds from the value you filled in.

NAT

If your PBX is operating in a network connected to the internet through a single router, your PBX is behind NAT. The NAT device has to be instructed to forward the right inbound packets (from internet) to the PBX server. Usually you have to configure NAT settings when you want to register a remote extension to the PBX or when you need connect to the PBX via SIP trunk.

Yeastar S-Series supports 3 methods to configure NAT: STUN, External IP Address and External Host.

1) STUN

The screenshot shows a configuration form for STUN. It contains the following fields:

- NAT Type:** A dropdown menu with 'STUN' selected.
- STUN Address:** A dropdown menu with 'stun.yeastar.com' selected.
- External Refresh Interval:** An empty text input field.
- Local Network Identification:** Two empty text input fields separated by a slash, with a plus icon to the right.
- NAT Mode:** A dropdown menu with 'Yes' selected.

Figure 9-2 STUN

Table 9-5 STUN Configuration Parameters

Option	Description
STUN Address	Choose a STUN address in the drop-down list or customize with a STUN address and STUN port.
External Refresh Interval	If an external host has been supplied, you may specify how often the system will perform a DNS query on this host. This value is specified in seconds.
Local Network Identification	Used to identify the local network using a network number/subnet mask pair when the system is behind a NAT or firewall. Some examples are as follows: "192.168.0.0/255.255.0.0", "10.0.0.0/255.0.0.0", and "172.16.0.0/12".
NAT Mode	Global NAT configuration for the system. The options are as follows: <ul style="list-style-type: none"> Yes: use NAT and ignore the address information in the SIP/SDP headers and reply to the sender's IP

	<p>address/port.</p> <ul style="list-style-type: none"> • No: use NAT mode only according to RFC3581. • Never: never attempt NAT mode or RFC3581 support. • Route: use NAT but do not include rport in headers.
--	--

2) External IP Address

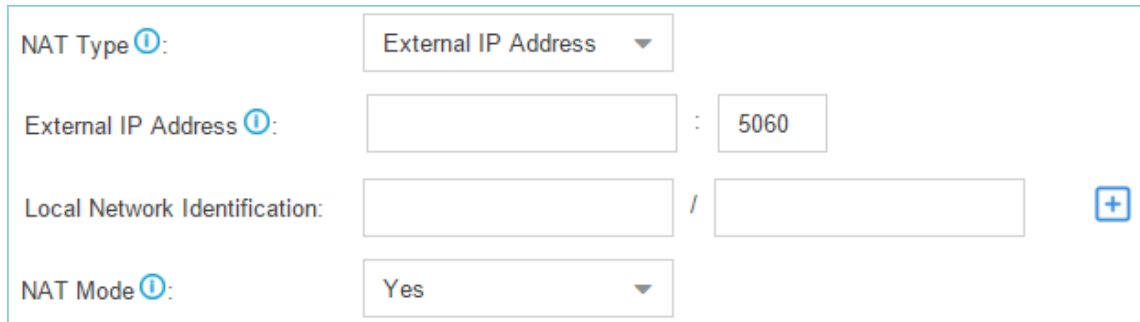

NAT Type ⓘ: External IP Address ▼

External IP Address ⓘ: [] : 5060

Local Network Identification: [] / [] +

NAT Mode ⓘ: Yes ▼

Figure 9-3 NAT Settings – External IP Address

Table 9-6 External IP Address Configuration Parameters

Option	Description
External IP Address	The IP address that will be associated with outbound SIP messages if the system is in a NAT environment.
Local Network Identification	Used to identify the local network using a network number/subnet mask pair when the system is behind a NAT or firewall. Some examples are as follows: “192.168.0.0/255.255.0.0”, “10.0.0.0/255.0.0.0”, and “172.16.0.0/12”.
NAT Mode	Global NAT configuration for the system. The options are as follows: <ul style="list-style-type: none"> • Yes: use NAT and ignore the address information in the SIP/SDP headers and reply to the sender's IP address/port. • No: use NAT mode only according to RFC3581. • Never: never attempt NAT mode or RFC3581 support. • Route: use NAT but do not include rport in headers.

3) External Host

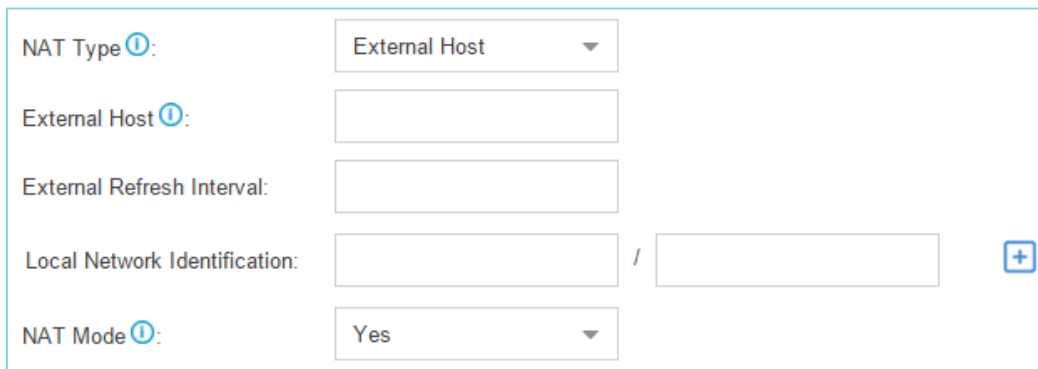

NAT Type ⓘ: External Host ▼

External Host ⓘ: []

External Refresh Interval: []

Local Network Identification: [] / [] +

NAT Mode ⓘ: Yes ▼

Figure 9-4 NAT Settings – External Host

Table 9-7 External Host Configuration Parameters

Option	Description
External Host	Alternatively you can specify an external host, and the system will perform DNS queries periodically. This setting is only required when your external IP address is not static. It is recommended that a static public IP address be used with this system. Please contact your ISP for more information.
External Refresh Interval	If an external host has been supplied, you may specify how often the system will perform a DNS query on this host. This value is specified in seconds.
Local Network Identification	Used to identify the local network using a network number/subnet mask pair when the system is behind a NAT or firewall. Some examples are as follows: "192.168.0.0/255.255.0.0", "10.0.0.0/255.0.0.0", and "172.16.0.0/12".
NAT Mode	Global NAT configuration for the system. The options are as follows: <ul style="list-style-type: none"> • Yes: use NAT and ignore the address information in the SIP/SDP headers and reply to the sender's IP address/port. • No: use NAT mode only according to RFC3581. • Never: never attempt NAT mode or RFC3581 support. Route: use NAT but do not include rport in headers.

Codec

A codec is a compression or decompression algorithm that used in the transmission of voice packets over a network or the Internet. S-Series supports G711 a-law, u-law, GSM, H261, H263, H263P, H264, SPEEX, G722, G726, ADPCM, G719A, MPEG4 and iLBC.

Note:

If you would like to use G.729, please enter your license. The system have embedded the G729, you can test it directly without purchasing license. But for copyright protection, we suggest you to buy it after testing it successfully. After you buy the license from DIGIUM, you should enter G729 license at the "G729 License Key".

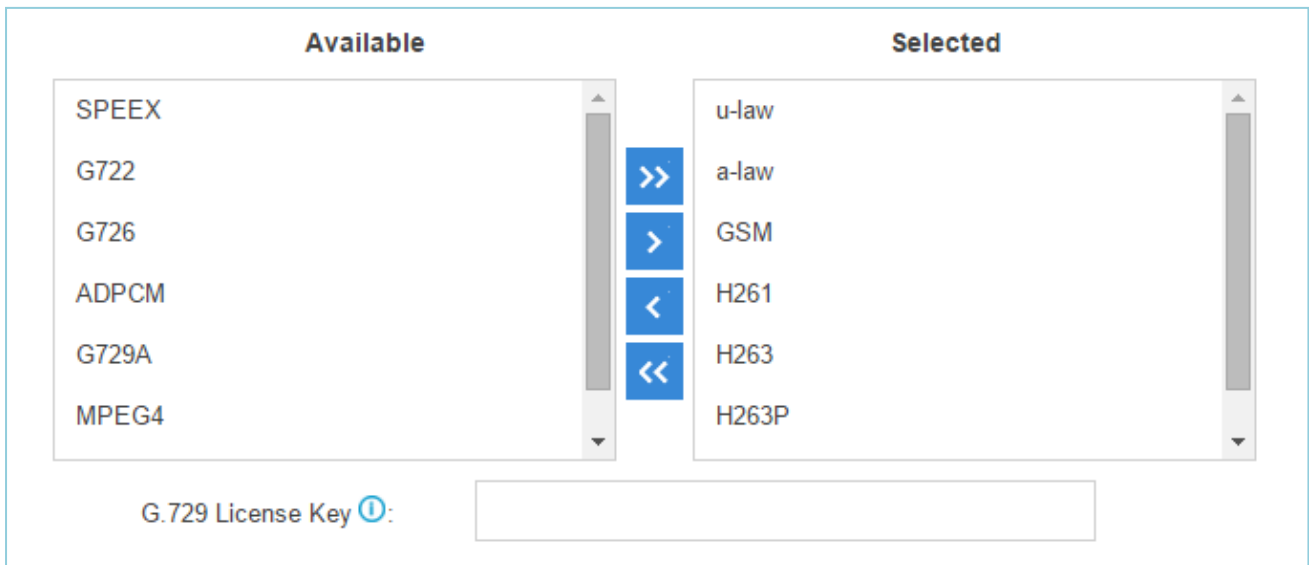

Figure 9-5 Codec Settings

TLS

Yeastar S-Series supports TLS protocol, to use TLS, you need enable TLS via **Settings > PBX > General > SIP > TLS**. Check the TLS configuration parameters below.

Table 9-8 TLS Configuration Parameters

Option	Description
Enable TLS	Check the checkbox to enable TLS.
TLS Port	TLS Port used for SIP registrations. The default is 5061.
Certificate	Choose the TLS certificates.
TLS Verify Server	If set to no, don't verify the servers certificate when acting as a client. If you don't have the server's CA certificate you can set this and it will connect without requiring TLS CA file. The default is no.
TLS Verify Client	If set to yes, verify certificate when acting as server. The default is no.
TLS Ignore Common Name	If set to yes, verify certificate when acting as server. The default is no.
TLS Client Method	Specify protocol for outbound client connections. The default is sslv2.

Session Timer

A periodic refreshing of a SIP session that allows both the user agent and proxy to determine if the SIP session is still active.

Table 9-9 Session Timer Configuration Parameters

Option	Description
Session-timers	Choose the session timers mode on the system: <ul style="list-style-type: none"> No: do not include "timer" value in any field Supported: include "timer" value in Supported header

	<ul style="list-style-type: none"> • Require: include "timer" value in Require header • Forced: include "timer" value in both "Supported" and "Required" header. <p>The default is Supported.</p>
Session-expires	The max refresh interval in seconds.
Session-minse	The min refresh interval in seconds, it must not be less than 90.

QoS

QoS (Quality of Service) is a major issue in VoIP implementations. The issue is how to guarantee that packet traffic for a voice or other media connection will not be delayed or dropped due interference from other lower priority traffic. When the network capacity is insufficient, QoS could provide priority to users by setting the value.

Tos SIP:	CS3
Tos Audio:	EF
Tos Video:	AF41
Cos SIP:	3
Cos Audio:	5
Cos Video:	4

Figure 9-6 QOS

T.38

<input type="checkbox"/> Re-invite SDP Not Add T.38 Attribute ⓘ	
Error Correction ⓘ:	FEC
T.38 Max BitRate ⓘ:	14400

Figure 9-7 T.38

- **Re-invite SDP Not Add T.38 Attribute**
If set to yes, SDP in re-invite packet will not add T.38 attributes.
- **Error Correction**
This sets the Error Correction Mode (ECM) for the Fax.
- **T.38 Max BitRate**
T38 Max Bit Rate.

Advanced

Table 9-10 SIP Advanced Settings

Option	Description
Allow RTP Re-invite	By default, the system will route media streams from SIP endpoints through itself. Enabling this option causes the system to attempt to negotiate the endpoints to route packets to each other directly, bypassing the system. It is not always possible for the system to negotiate endpoint-to-endpoint media routing.
Get Caller ID From	This decides the system will pull Caller ID header from which header field.
User Agent	This allows you to change the User-Agent field.
Get DID From	This decides the system will pull DID from which header field. If Remote-Party-ID is selected but the line does not support this, DID will be pulled from Invite header.
Send Remote Party ID	Whether to send the Remote-Party-ID in SIP header or not. The Default is no.
Send P Asserted Identify	Whether to send the P-Asserted-Identify in SIP header or not. The Default is no.
100rel	Check the option to enable 100rel.
Send Diversion ID	Whether to send the Diversion ID in SIP header or not. The Default is no.
Allow Guest	If enabled, it will allow the unauthorized INVITE coming into the PBX and the calls can be made. The default is no.

IAX

Table 9-11 IAX Configuration Parameters

Option	Description
UDP Port	UDP port used for IAX2 registrations. The default is 4569.
Bandwidth	Control which codecs to be used based on bandwidth consumption.
Maximum Registration/ Subscription Time	Maximum duration (in seconds) of an IAX registration. The default is 1200 seconds.
Minimum Registration/ Subscription Time	Minimum duration (in seconds) of an IAX registration. The default is 60 seconds.
Codec	Choose the codec.

Recording

This chapter explains how to configure auto recording on Yeastar S-Series.

Yeastar S-Series supports auto recording for an established call. Go to **Settings > PBX > Recording** to configure auto recording settings.

Figure 10-1 Recording Prompt Settings

Table 10-1 Recording Configuration Parameters

General Preferences	
Storage Location	Click the option to link the Storage settings. In the storage settings, you can configure where to store recording files.
Internal Call Being Recorded Prompt	If the internal call has enabled call recording, this prompt will notify the called party that the call will be recorded.
Outbound/Inbound Call Being Recorded Prompt	If the external call (outbound/inbound/callback) has enabled call recording, this prompt will notify the called party that the call will be recorded.
Record Trunks	When a call reaches the selected trunk, it will be recorded.
Record Extensions	The selected extensions will be recorded.
Record Conferences	The selected conferences will be recorded.

Event Center

Yeastar S-Series can monitor system events and logs, then send email notifications to the specified contacts.

Event Settings

The system events are divided into three categories:

Operation

- ✓ Modify Administrator Password
- ✓ User Login Success
- ✓ User Login Failed
- ✓ User Locked

Telephony

- ✓ Register SIP Trunk Failed
- ✓ Service Provider Unreachable
- ✓ Outgoing Call Failed

System

- ✓ CPU Overload
- ✓ Memory Overload
- ✓ Concurrent Calls Overload
- ✓ Disk Failure
- ✓ Storage Space Full
- ✓ Network Attacked
- ✓ System Reboot
- ✓ System Upgrade
- ✓ System Restore

- Turn on **Record** to decide whether to record the event.
- Turn on **Notification** to decide whether to send notification.
- Click  to edit the notification template.





Name	Record	Notification	Edit Notification Template
Operation			
Modify Administrator Password	<input checked="" type="checkbox"/> On	<input type="checkbox"/> Off	
User Login Success	<input checked="" type="checkbox"/>	<input type="checkbox"/>	
User Login Failed	<input checked="" type="checkbox"/>	<input type="checkbox"/>	
User Lockout	<input checked="" type="checkbox"/>	<input type="checkbox"/>	

Figure 11-1 Event Settings

Notification Contacts

The administrator could add contacts here to define where to send the notifications. The system supports to send Email notification, Call notification and SMS notification.

Click [Add](#) to add a contact.

Figure 11-2 Notification Contacts

Table 11-1 Notification Contact Configuration Parameters

Option	Description
Choose Contact	Choose a contact from the drop-down menu. The selected contact will receive alert emails, SMS messages or calls.
Notification Method	Select how to notify the contact when the event occurs. <ul style="list-style-type: none"> • Email • SMS • Call Extension • Call Mobile
Email	When events occur, send notification emails to this address. If the Notification Method is Email, this field must be entered.
Mobile Number	When events occur, call or send SMS to this mobile number. If the Notification Method is Phone Call or SMS, this field must be entered.

Event Log

Go to **Settings > Event Center > Event Log** to check the event log.

You can filter the event logs by selecting a event type, event name, and specifying a certain time period. Click **Search**, the matching results will be displayed.

Event Log

Event Type ⓘ:

Event Name ⓘ:

Time ⓘ:

Time	Type	Event Name	Event Message
2016-04-17 17:26:43	operation	User Login Success	User login Success. UserName: admin; I...
2016-04-15 00:25:32	operation	User Login Success	User login Success. UserName: admin; I...
2016-04-14 00:02:58	operation	User Login Success	User login Success. UserName: admin; I...
2016-04-13 21:29:05	operation	User Login Success	User login Success. UserName: admin; I...
2016-04-12 21:48:02	operation	User Login Success	User login Success. UserName: admin; I...
2016-04-12 21:09:03	operation	User Login Success	User login Success. UserName: admin; I...
2016-04-12 19:42:17	operation	User Login Success	User login Success. UserName: admin; I...
2016-04-08 00:49:30	operation	User Login Success	User login Success. UserName: admin; I...
2016-04-07 23:37:44	operation	User Login Success	User login Success. UserName: admin; I...

Page of 3 |

 Displaying 1 - 10 of 25 |
 rows per page

Figure 11-3 Event Log

CDR and Recording

In CDR and Recording center, you can check all the call logs and recordings on the system. You can run reports against the logs and filter on the following:

- Time
- Call From
- Call To
- Call Duration
- Talk Duration
- Status
- Trunk
- Communication Type
- Account Code

You can perform the following operations on the filtered call report:

- **Download Searched Result**
Click Download the Records to download the searched records.
- **Edit List Options**

Click  to choose which options will be displayed on the logs page.

- **Play Recording File**

Click  to play the recording file.

- **Download Recording File**

Click  to play the recording file.

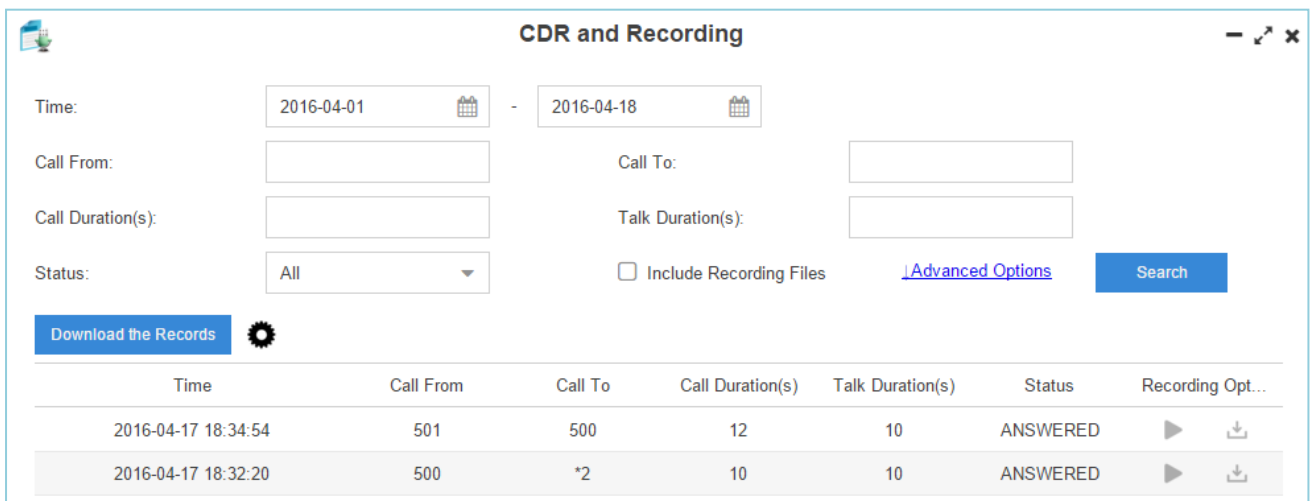

The screenshot shows the 'CDR and Recording' interface. It includes search filters for Time (2016-04-01 to 2016-04-18), Call From, Call To, Call Duration(s), Talk Duration(s), and Status (All). There are buttons for 'Download the Records', 'Include Recording Files', 'Advanced Options', and 'Search'. Below the filters is a table with columns: Time, Call From, Call To, Call Duration(s), Talk Duration(s), Status, and Recording Opt... The table contains two rows of call records.















Time	Call From	Call To	Call Duration(s)	Talk Duration(s)	Status	Recording Opt...
2016-04-17 18:34:54	501	500	12	10	ANSWERED	 
2016-04-17 18:32:20	500	*2	10	10	ANSWERED	 

Figure 12-1 CDR and Recording

PBX Monitor

The PBX monitors the status of Extensions, Trunks and Concurrent Call. Go to **PBX Monitor** to check the real time status.





Extension Status

Extension				
Status	Extension	Name	Type	IP And Port
	1000	1000	SIP FXS	Span2_Port1
	1001	1001	FXS	Span2_Port2
	1002	1002	SIP	192.168.12.73:5065
	1003	1003	SIP	192.168.12.153:5088
	1004	1004	SIP	192.168.12.73:36984;tra...
	1005	1005	SIP	
	1006	1006	SIP	
	1007	1007	SIP	
	1008	1008	SIP	
	1009	1009	SIP	192.168.12.139:41594;tr...

Navigation: << < 1/2 > >> Refresh Go to Go Displaying 1 - 10 of 20 10 ▾

Figure 13-1 Extension Status

Table 13-1 Extension Status Description

Status	Description
	The extension is idle.
	The extension is ringing.
	The extension is unavailable.
	The extension is busy.
	The extension is on hold.



Malfunction in FXS interface; please examine the relevant interface and module.

Trunk Status

Trunks			
Status	Trunk Name	Type	Hostname/IP/Port
	SIP152	SIP	192.168.12.152
	IMS180	SIP	172.31.2.17
	SPS139	SIP-P2P	192.168.12.139
	SIP212	SIP	192.168.3.212
	BRI1-1	BRI	Span1_Port1
	BRI1-2	BRI	Span1_Port2
	GSM1-7	GSM	Span1_Port7
	FXO2-7	FXO	Span2_Port7
	FXO2-8	FXO	Span2_Port8

Navigation: << < 1/1 > >> Refresh Go to Go Displaying 1 - 9 of 9 10 ▾

Figure 13-2 Trunk Status

Table 13-2 FXO Trunk Status Description

FXO Trunk Status	
	The trunk is idle.
	The trunk is busy in use.
	No PSTN line plugged in FXO interface.
	Malfunction in FXO interface; please examine the relevant interface and module.

Table 13-3 GSM/CDMA/3G Trunk Status Description

GSM/CDMA/3G Trunk Status	
	The trunk is idle, the icon shows the signal strength.
	The trunk is busy.







	The module is powered off.
	No SIM card inserted.
	No signal.
	PIN/PUK Error.
	GSM network registration failed.
	Malfunction in module; please examine the relevant module.

Table 13-4 BRI/E1/T1 Trunk Status Description







BRI/E1/T1 Trunk Status	
	The trunk is idle.
	<ol style="list-style-type: none"> 1. Broken module/interface. 2. Incorrect physical layer configuration. 3. Service provider did not activate the trunk.
	<ol style="list-style-type: none"> 1. Incorrect protocol layer configuration. 2. Service provider did not activate the trunk.
	<ol style="list-style-type: none"> 1. Malfunction in interface/module; please examine the relevant interface/module. 2. No trunk plugged in. 3. Service provider did not activate the trunk.

Table 13-5 VoIP Trunk Status Description

VoIP Trunk Status	
	<ol style="list-style-type: none"> 1. Registered 2. Unmonitored
	Registering.
	<ol style="list-style-type: none"> 1. Unreachable 2. Registration failed, caused by: <ul style="list-style-type: none"> • wrong password • wrong authentication name • wrong username • transport type inconsistent

Concurrent Call

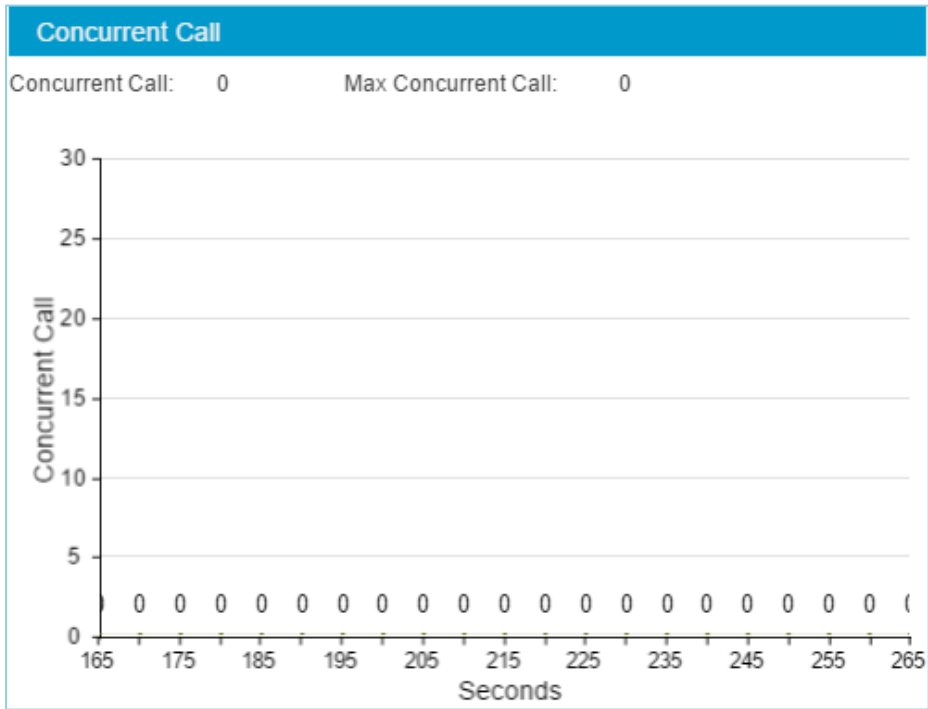

Figure 13-3 Concurrent Call

Resource Monitor

Resource Monitor allows you to monitor the CPU usage, memory usage, disk utilization and network flow.

Information

On this page, you can check the system information, including Product, SN, Hardware version, Software version etc.

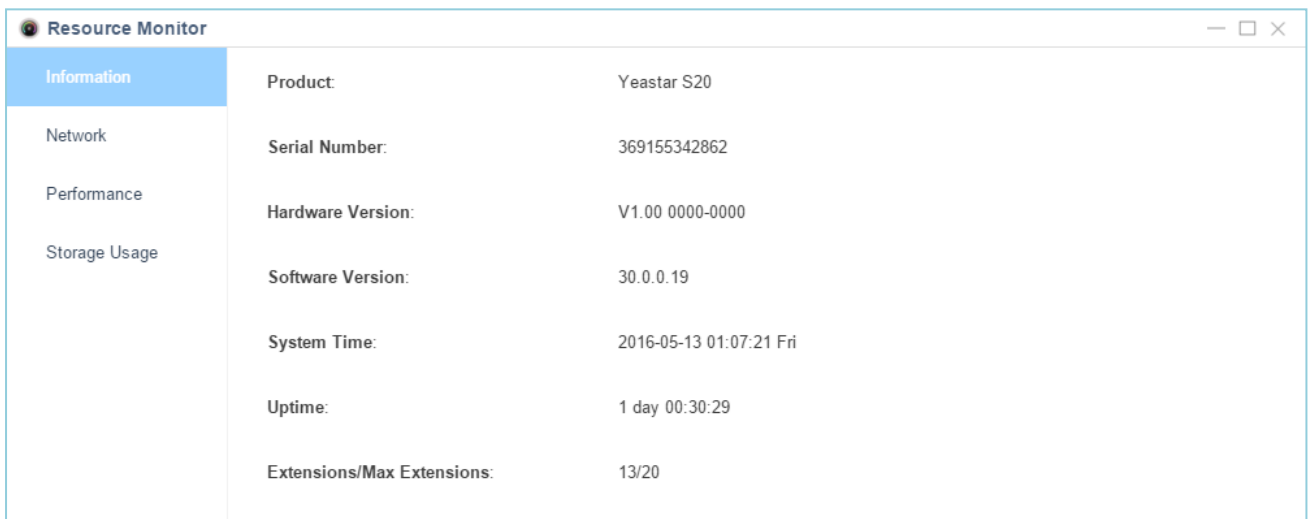

Resource Monitor	
Information	Product: Yeastar S20
Network	Serial Number: 369155342862
Performance	Hardware Version: V1.00 0000-0000
Storage Usage	Software Version: 30.0.0.19
	System Time: 2016-05-13 01:07:21 Fri
	Uptime: 1 day 00:30:29
	Extensions/Max Extensions: 13/20

Figure 14-1 System Information

Network

Click on **Network** tab to view the system's network status.

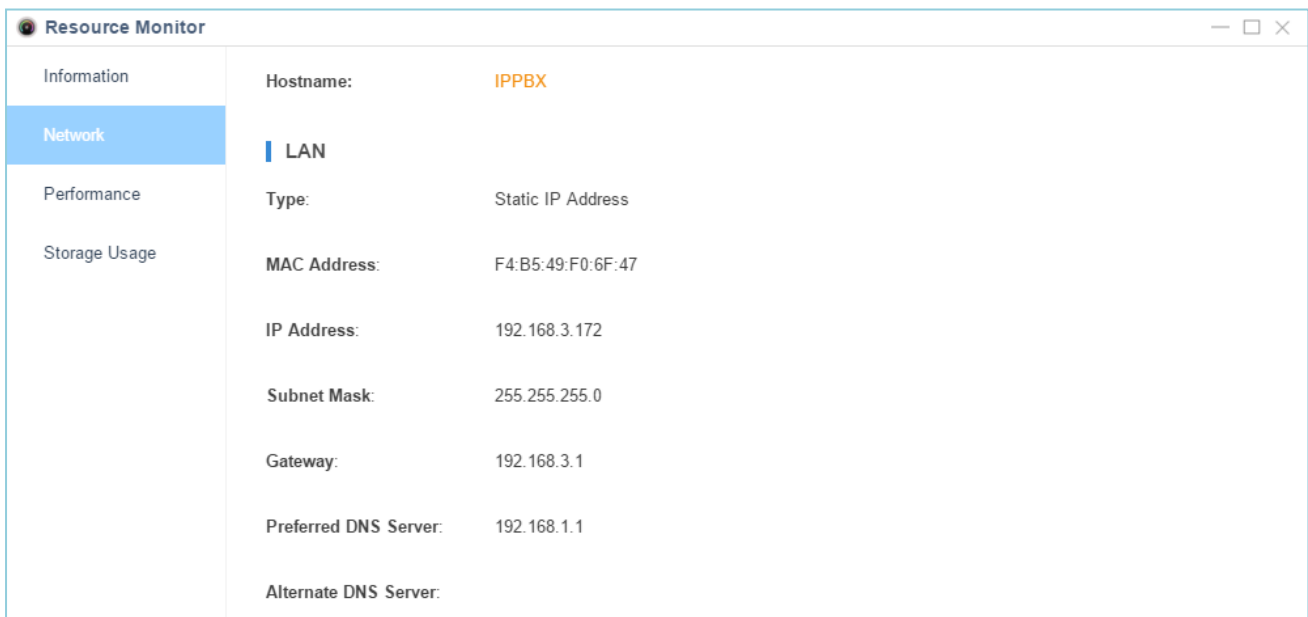

Resource Monitor	
Information	Hostname: IPPBX
Network	LAN
Performance	Type: Static IP Address
Storage Usage	MAC Address: F4:B5:49:F0:6F:47
	IP Address: 192.168.3.172
	Subnet Mask: 255.255.255.0
	Gateway: 192.168.3.1
	Preferred DNS Server: 192.168.1.1
	Alternate DNS Server:

Figure 14-2 Network Status

Performance

Click on **Performance** tab to view the resource utilization data. The information of the chart will be shown upon mouseover.

CPU

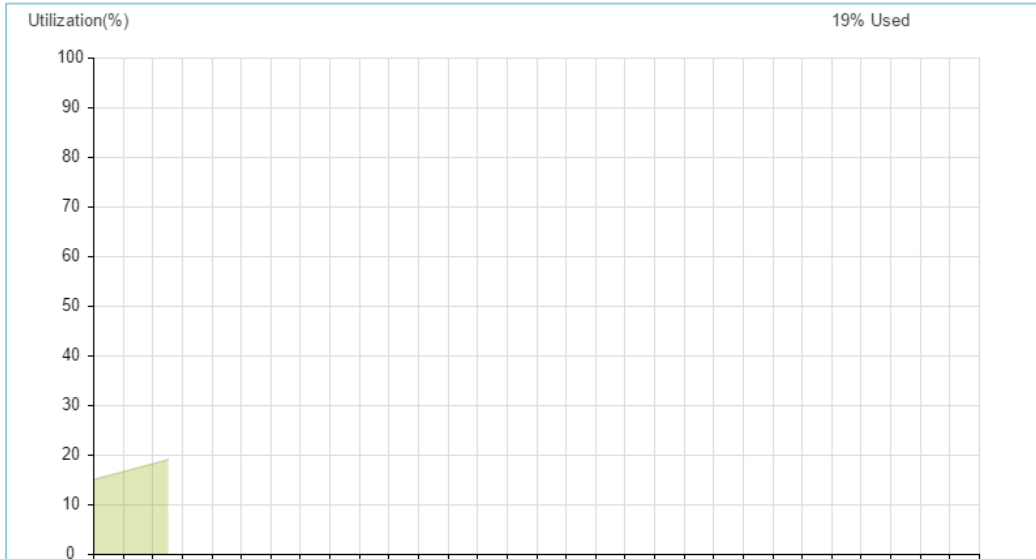

Figure 14-3 CPU Status

Memory

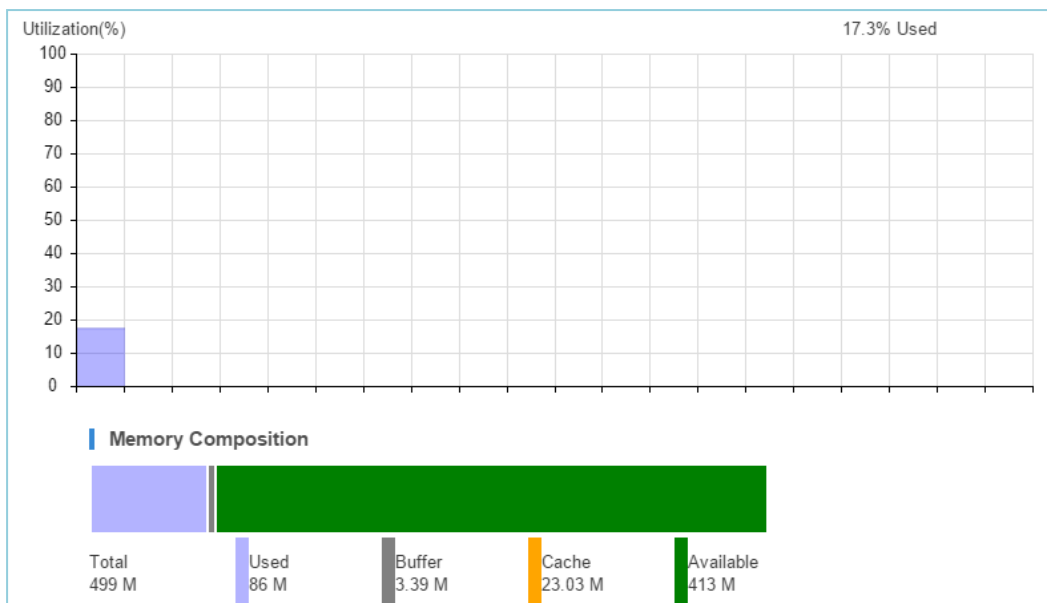

Figure 14-4 Memory Status

LAN

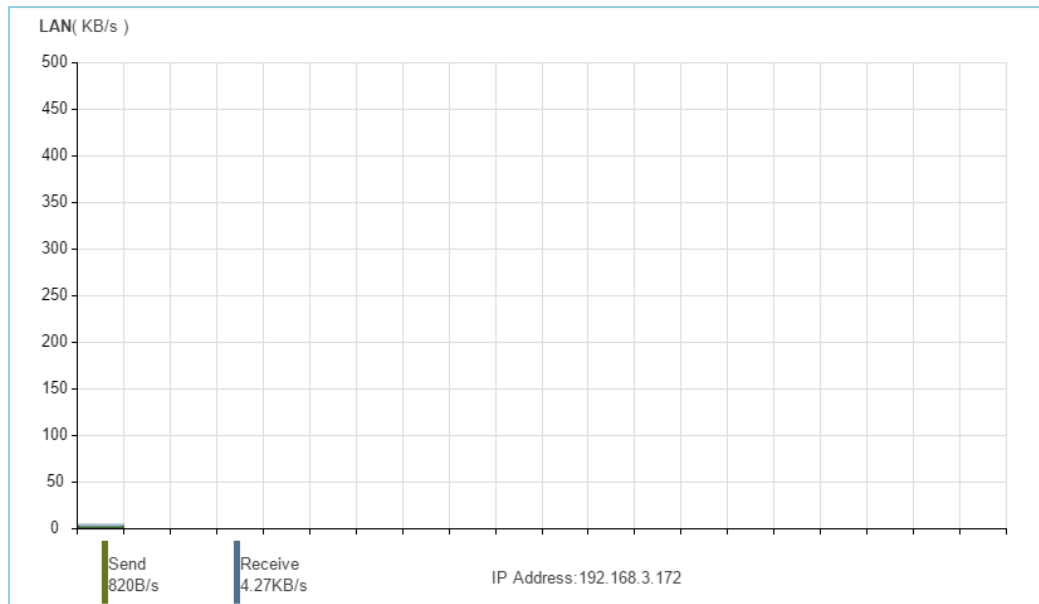

Figure 14-4 LAN Status

Storage Usage

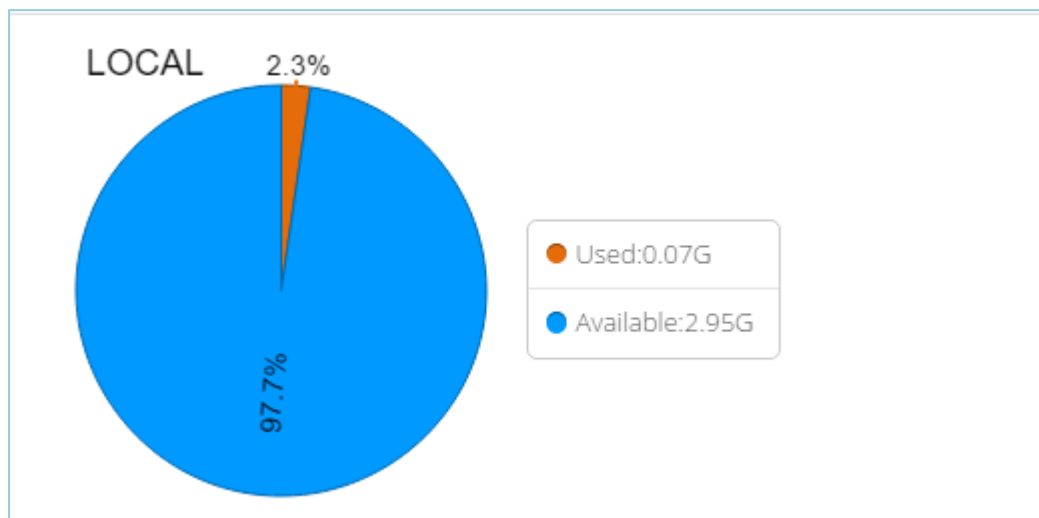

Figure 14-5 Storage Usage

Maintenance

This chapter describes system maintenance settings including the followings:

- [Upgrade](#)
- [Backup and Restore](#)
- [Reboot and Reset](#)
- [System Log](#)
- [Operation Log](#)
- [Trouble Shooting](#)

Upgrade

Yeastar S-Series provides automatic updates; new firmware file will be checked via a cloud server. In addition, you can upgrade firmware manually. The system supports browsing firmware file from local PC and supports HTTP method, TFTP method.

Go to **Maintenance > Upgrade** to do upgrade.

Note:

1. If “Reset configuration to Factory Defaults” is enabled, the system will reset to factory default settings.
2. When update the firmware, please don't turn off the power. Or the system will get damaged.
3. If you are trying to upgrade through HTTP or do auto upgrade, please make sure that the system is able to visit the Internet, or it cannot access Yeastar website to get the firmware file, causing the upgrade fail.

Automatic Upgrade

Figure 15-1 Automatic Upgrade

- **Never Check Updates:** never check updates from the cloud server.
- **Check for Updates and let me choose whether to update:** set when to do check the updates automatically from the cloud server.
- **Check for updates and automatically install:** automatically downloads and installs firmware

updates without even asking.

Browsing File from Local PC to Upgrade

1. Choose **Type** "Browsing File".
2. Click **Browse**, select the firmware file from your local PC. Note that the file should be a BIN file.
3. Click **Upload** to start uploading.

The screenshot shows the 'Upgrade Manually' section of a web interface. It includes a checkbox for 'Reset Configuration to Factory Defaults'. Below that, the 'Type' dropdown menu is set to 'Browsing File'. Underneath, there is a 'Choose a file:' label, a text input field containing 'Please select', a 'Browse...' button, and an 'Upload' button.

Figure 15-2 Upgrade Manually – Browsing File

Upgrade through HTTP

1. On the Firmware Upgrade page, choose "Download From HTTP Server".
2. Enter the HTTP URL.
Note: the HTTP URL should be a **BIN** file download link.
3. Click **Download** to start downloading the file from Yeastar HTTP server.

The screenshot shows the 'Upgrade Manually' section of a web interface. It includes a checkbox for 'Reset Configuration to Factory Defaults'. Below that, the 'Type' dropdown menu is set to 'Download From HTTP Serve'. Underneath, there is an 'HTTP URL:' label, an empty text input field with a red border and a red exclamation mark icon to its right, and a 'Download' button.

Figure 15-3 Upgrade Manually - HTTP

Upgrade through TFTP

1. Download firmware file from Yeastar website to your local PC.
2. Create a tftp server, here take Tftpd32 for example.
3. Configure tftp server. Click **Browse** button to select the firmware file upgraded patch.

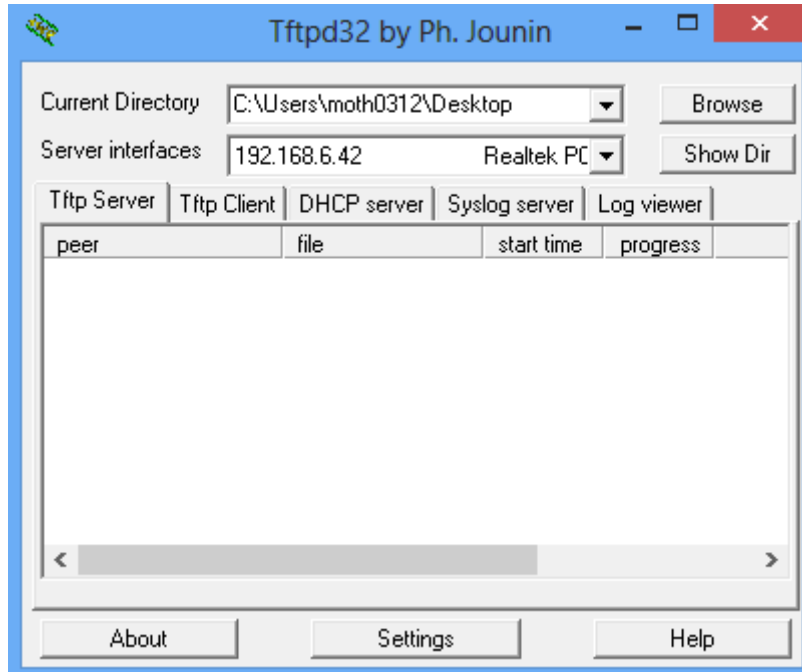

Figure 15-4 TFTP32 Settings

4. Go to Yeastar system upgrade page, select **Type** as "Download From TFTP Server".
5. Fill in the **TFTP Server IP**, the IP should be the local PC's IP address.
6. Fill in the name of firmware update. It should be a BIN file name.

Upgrade Manually

Reset Configuration to Factory Defaults

Type:

TFTP Server:

File Name:

Figure 15-5 Upgrade Manually – TFTP

7. Click **Download** to download the file and start to upgrade.

Backup and Restore

Yeastar S-Series provides Backup and Restore feature, which allows you to create a complete backup of the system configurations to a file.

Notes:

1. When you have updated the firmware version, it's not recommended to restore using old package.

2. Backup from an earlier version cannot be restored on the system of a later version.

- **Create a New Backup**

Click **Backup** to create a new backup.

Figure 15-6 Create New Backup File

- **Upload a Backup**

Click **Upload** to upload a backup.

Figure 15-7 Upload a Backup File

- **Restore**

To restore the configuration data, select a backup and click . Reboot the system to take effect.

Please note the current configurations will be OVERWRITTEN with the backup data.



<input type="checkbox"/>	Name	Backup Time	Memo	Download	Restore	Delete
<input type="checkbox"/>	q.bak	2016-04-17 21:08...				

Figure 15-8 Restore Backup File

Reset and Reboot

Users could reset and reboot the system via **Maintenance > Reset and Reboot**.

- Click **Reboot** to reboot the system
- Click **Reset** to reset the system to factory configurations.

System Log

Users could check system logs under **Maintenance > System Log**.

The system logs will be generated everyday automatically and a log file will be listed in the System Log.

1) System Log Settings

You can set the debug level by checking/unchecking the options "Info", "Notice", "Warning", "Error" and "Debug", click Save and Apply to save the changes.

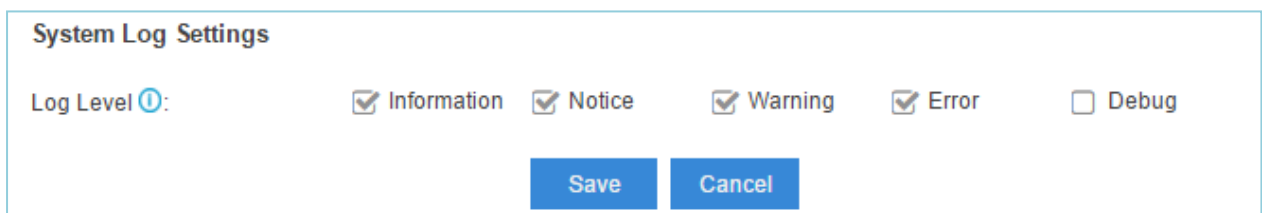

The screenshot shows the 'System Log Settings' configuration page. It features a 'Log Level' section with five checkboxes: 'Information', 'Notice', 'Warning', 'Error', and 'Debug'. The first four are checked, while 'Debug' is unchecked. Below the checkboxes are two buttons: 'Save' and 'Cancel'.

Figure 15-9 System Log Settings

2) System Log

Click  to download the file to your local PC.

Click  to delete the log file.

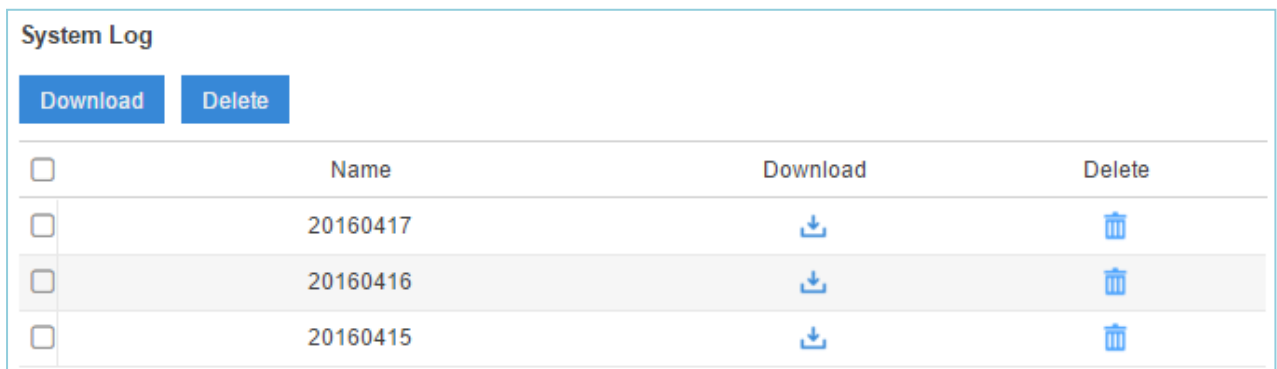

The screenshot shows the 'System Log' interface. At the top, there are 'Download' and 'Delete' buttons. Below is a table with columns for selection, Name, Download, and Delete. Three log files are listed with IDs 20160417, 20160416, and 20160415. The row for 20160416 is highlighted.







<input type="checkbox"/>	Name	Download	Delete
<input type="checkbox"/>	20160417		
<input type="checkbox"/>	20160416		
<input type="checkbox"/>	20160415		

Figure 15-10 System Log

Operation Log

Go to **Maintenance > Operation Log** to check the operation log.

You can filter the logs by user, IP address, and specifying a certain time period. Click Search, the matching results will be displayed.

Operation Log

User:

IP Address:

Time: -

Time	User	IP Address	Operation	Details
2016-04-17 21:...	admin	192.168.6.13	Backup and Restore : Backup	
2016-04-17 21:...	admin	192.168.6.13	Login	username: admin
2016-04-17 19:...	admin	192.168.12.23	Ethernet Capture Tool : Stop	
2016-04-17 19:...	admin	192.168.12.23	Ethernet Capture Tool : Start	
2016-04-17 19:...	admin	192.168.12.23	Login	username: admin
2016-04-17 18:...	admin	192.168.6.13	Login	username: admin
2016-04-17 17:...	admin	192.168.12.23	Trunks : Add	Trunk Name: SIP168
2016-04-17 17:...	admin	192.168.12.23	Login	username: admin

Page 1 of 4 | Displaying 1 - 10 of 33 | 10 rows per page

Figure 15-11 Operation Log

Troubleshooting

Yeastar S-Series provides multiple tools on the Web GUI for you to do troubleshooting. Go to **Maintenance > Troubleshooting** to check the tools.

Ethernet Capture Tool

Ethernet Interface:

IP Address:

Port:

Figure 15-12 Ethernet Capture Tool

1. Fill in the target IP address and port.
2. Click **Start** to start capturing logs.
3. Click **Stop** to stop capturing.
4. Click **Download** to download the file to your local PC and analyze it.

The output result is in .tar format. Decompress the file and open the .pcap file using Wireshark software.

DAHDI Monitor Tool

This feature is used to monitor PSTN trunks on the system. Users could choose a PSTN trunk, then start to monitor the trunk.



Figure 15-13 DAHDI Monitor Tool

1. Choose a trunk from the drop-down menu.
2. Click **Start** to start capturing logs.
3. Click **Stop** to stop capturing.
4. Click **Download** to download the file to your local PC and analysis it.

The output result is in .tar format. Decompress the file and open the .raw files using Audition software.

IP Ping

1. Enter the target IP address or hostname.
2. Click **Start** to start capturing logs.

The output result will display in the window as below.

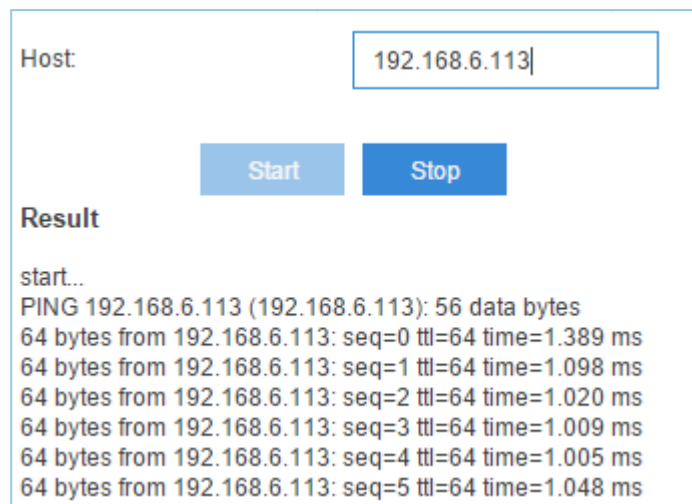
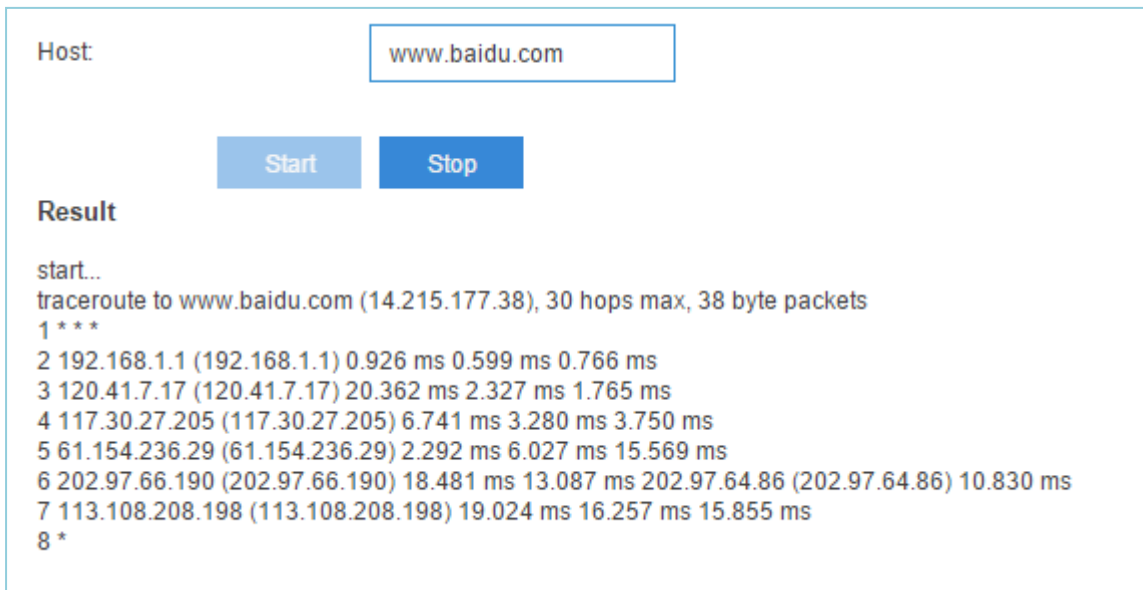

Figure 15-14 IP Ping

Traceroute

1. Enter the target IP address or hostname.
2. Click **Start** to start capturing logs.

The output result will display in the window as below.



Host:

Result

```
start..
traceroute to www.baidu.com (14.215.177.38), 30 hops max, 38 byte packets
1 ***
2 192.168.1.1 (192.168.1.1) 0.926 ms 0.599 ms 0.766 ms
3 120.41.7.17 (120.41.7.17) 20.362 ms 2.327 ms 1.765 ms
4 117.30.27.205 (117.30.27.205) 6.741 ms 3.280 ms 3.750 ms
5 61.154.236.29 (61.154.236.29) 2.292 ms 6.027 ms 15.569 ms
6 202.97.66.190 (202.97.66.190) 18.481 ms 13.087 ms 202.97.64.86 (202.97.64.86) 10.830 ms
7 113.108.208.198 (113.108.208.198) 19.024 ms 16.257 ms 15.855 ms
8 *
```

Figure 15-15 Traceroute

App Center

Yeastar S-Series has integrated Yeastar-designed applications into packages that can be installed on S-Series and managed with App Center.

Yeastar S-Series provides you with a variety of applications. This chapter introduces applications available at App Center and how to manage the applications.

What App Center Offers

Go to **App Center** to find out what App Center has to offer.

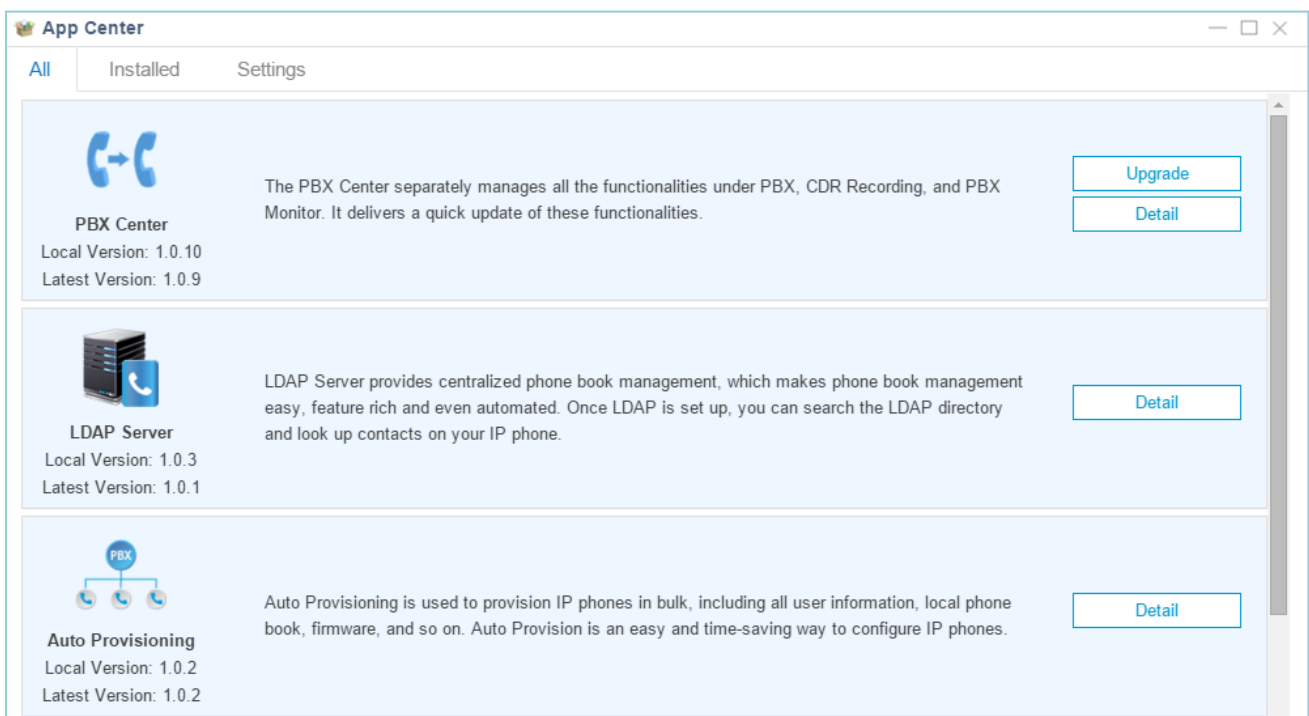

Figure 16-1 App Center

PBX Center

The PBX Center separately manages all the functionalities under PBX, CDR Recording, and PBX Monitor. It delivers a quick update of these functionalities.

LDAP Server

LDAP Server provides centralized phone book management, which makes phone book management easy, feature rich and even automated. Once LDAP is set up, you can search the LDAP directory and look up contacts on your IP phone.

For details of how to use LDAP server, please refer to **LDAP Server section**.

Auto Provisioning

Auto Provisioning is used to provision IP phones in bulk, including all user information, local phone book, firmware, and so on. Auto Provision is an easy and time-saving way to configure IP phones.

How to use Auto Provisioning, please refer to **Auto Provisioning section**.

Install Apps

Click **All** tab, find the application you'd like to install and click **Install**. Once the App is installed, it should appear in the **Main Menu**. You can also check the installed App in **App Center > Installed**.

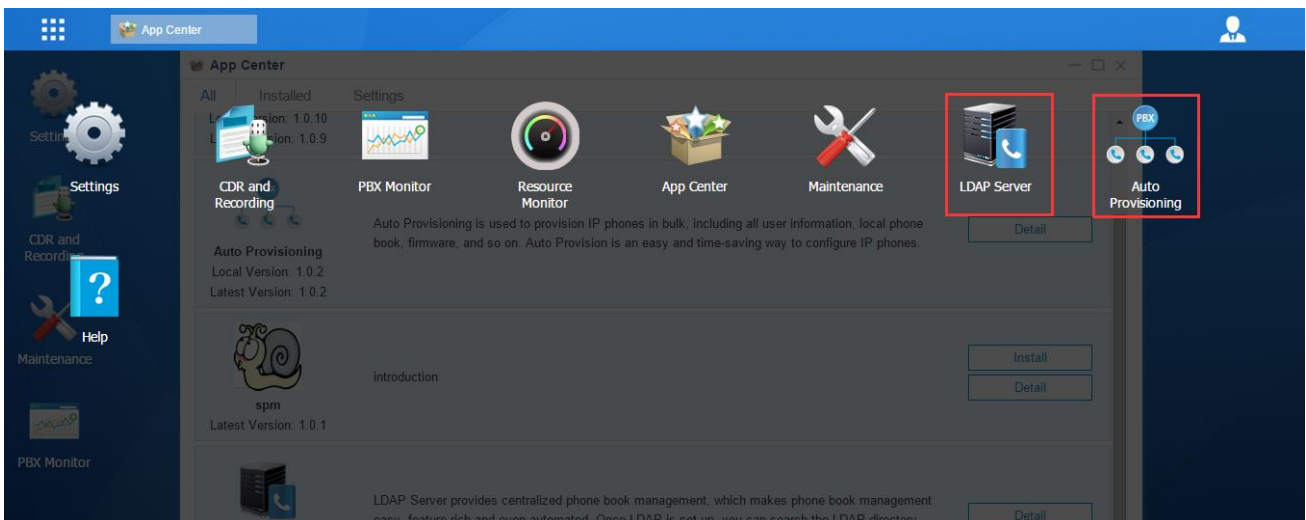

Figure 16-2 Installed Apps

Manage Apps

After installing Apps, you can manage them to keep them up-to-date and running smoothly. The instructions below explain how to update and uninstall Apps.

To uninstall App:

Go to App Center, select the App that you would like to uninstall, click Uninstall to uninstall the App.

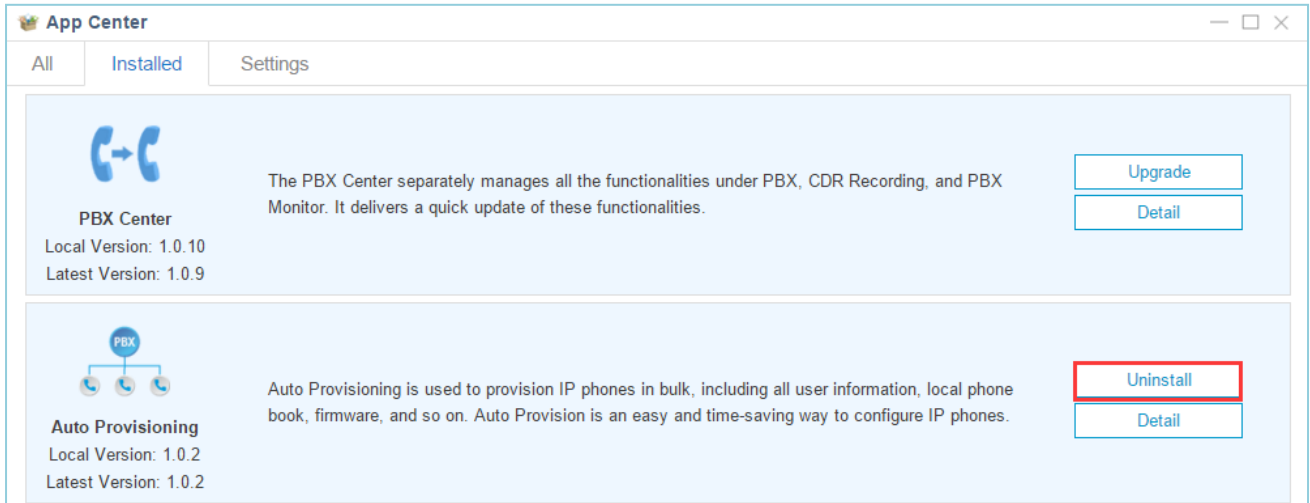

Figure 16-3 Uninstall App

NOTE:

PBX Center is the core module of the system, it cannot be uninstalled. You can only upgrade the App.

To update App, do any of the following:

- Click on **Installed** tab, choose one App and click **Upgrade** to update the App.

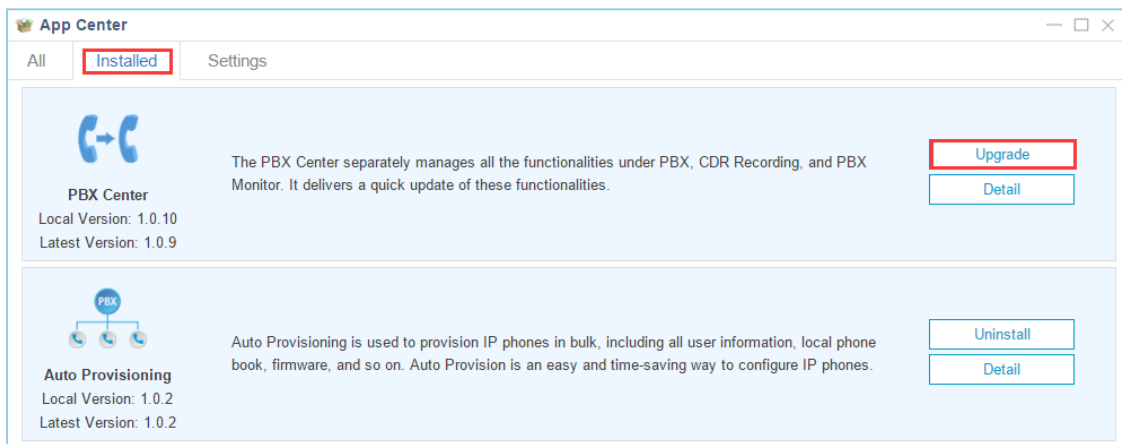

Figure 16-4 Update App

- Click on **Settings** tab, configure auto update for the selected Apps.

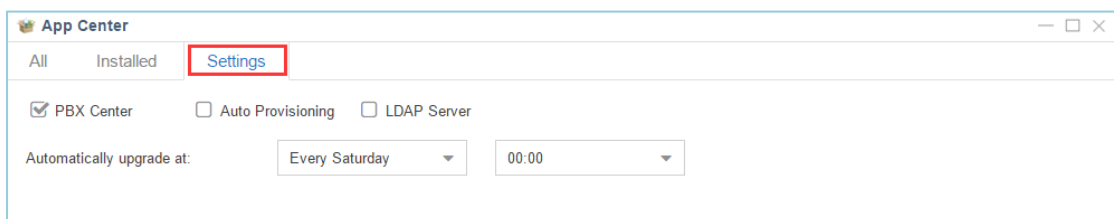

Figure 16-5 App Center Settings

LDAP Server

This section explains how to use S-Series LDAP with different phones. The configuration settings you enter in your phone will alter wildly dependant on how your LDAP server is configured. In this guide, the LDAP settings on IP phone are configured according to Yeastar S-Series LDAP default settings.

1. Configure LDAP Server Settings

- 1) Check the option “Enable” to enable LDAP server.
- 2) Default LDAP server settings as below:
 - **Base DN:** dc=pbx,dc=com
 - **PBX DN:** ou=pbx,dc=pbx,dc=com
 - **User Name:** cn=admin,dc=pbx,dc=com
 - **Password:** password

LDAP server is running

Enable

Base DN:	dc=pbx,dc=com	PBX DN:	ou=pbx,dc=pbx,dc=com
User Name:	cn=admin,dc=pbx,dc=com	Password:	password

Figure 17-1 LDAP Server Settings

2. Edit/Add Phone Book on LDAP Server

There is one default phone book that contains all the extension user contacts on the system. You can also create a new phone book and add contacts there.

NOTE:

Yeastar S-Series supports creating 1 phonebook on LDAP server, and supports up to 1000 contacts in one phonebook.

To add a phone book:

- 1) Click Add to add a new phone book. Name the phone book and click Save.

Add Phonebook

Phonebook Node: ou=Yeastar,dc=pbx,dc=com

Phonebook Name: Yeastar

Save Cancel

Figure 17- 2 Add Phonebook

- 2) Choose the phone book, click  to edit it.

Add Delete Import Export			
<input type="checkbox"/>	Phonebook Node	Edit	Delete
<input type="checkbox"/>	ou=pbx,dc=pbx,dc=com		
<input checked="" type="checkbox"/>	ou=Yeastar,dc=pbx,dc=com		

Figure 17-3 LDAP Phone Book

- 3) Fill in the contact information on the page, click  to add the contact in the phone book. Add other contacts in the same way.

Edit Phonebook

Add Delete

<input type="checkbox"/>	Nick Name	Edit	Delete
No items defined.			

Nick Name: Cathy

First Name: Catherine

Last Name: Huang

Email: catherine@yeasta.com

Mobile Number: 15880270666

Office Number: 6041

Home Number: 05925503309

Department: Marketing

Save Cancel

Navigation: << < 1/0 > >> Go to Go No items defined. 10

Figure 17-4 Edit LDAP Phonebook

To import a phone book:

- 1) Click **Import**, you will see a dialog window shown as below.

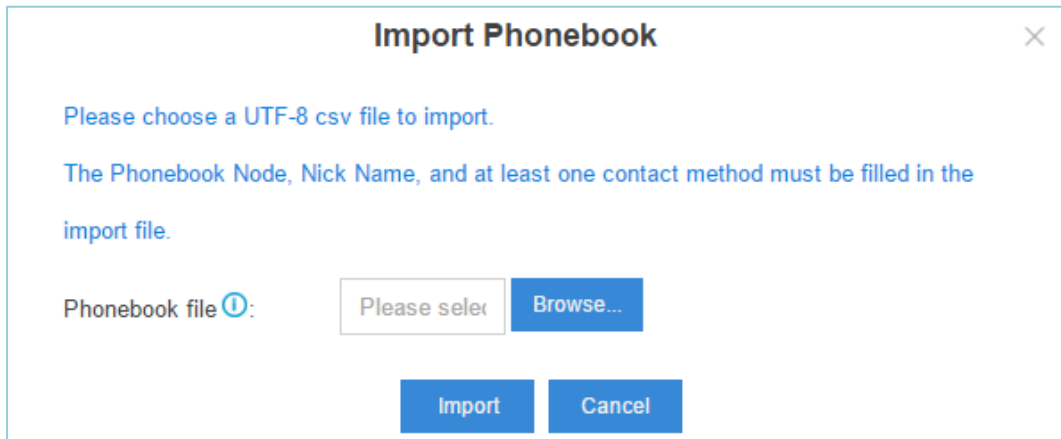

Figure 17-5 Import LDAP Phonebook

- 2) Click **Browse** and select the file to start uploading. The file must be a .csv file. Check the sample file below. You can export a phone book file from S-Series and use it as a sample to start with.

A	B	C	D	E	F	G	H	I	J
Phonebook N	Extension	Nick Name	First Name	Last Name	Email	Mobile Number	Office Number	Home Number	Department
Yeastar		Cathy	Catherine	Huang	catherine@	15880270666	6041	5925503309	Marketing
Yeastar		Abby	Abby	Lin	abby@yeast	1737347484	3744	5924747575	Support
Yeastar		Betty	Betty	Yan	betty@yeas	1837492998	8203	592747382	Sales
Yeastar		Echo	echo	Chan	echo@yeast	17372515362	8193	5929283847	Sales

Figure 17-6 Phonebook File

To export a phone book:

Select the checkbox of the phone book, click **Export**, the selected phone book will be exported to your local PC.

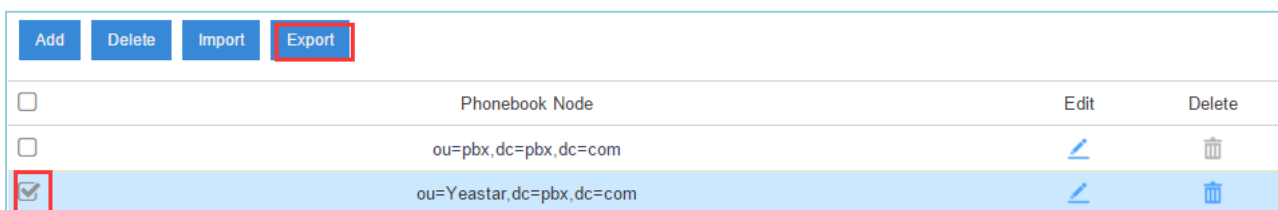

Figure 17-7 Export LDAP Phonebook

3. Configure LDAP Settings on Your Phone

Here we take Yealink T-26 IP Phone (Version 6.73.0.50) as an example.

NOTE:

Operations may be different for different IP phone with different version.

LDAP Attributes

The following table lists the most common attributes used to configure the LDAP lookup on IP phones.

LDAP Attribute	Name
gn	gn – givenName. First Name.
cn	cn – commonName. LDAP attribute is made up from given name joined to surname.
sn	sn – surname. Last name or family name
dn	dn – distinguishedName. Unique identifier for each entry
dc	Domain component
telephoneNumber	Office phone number
homePhone	Mobile Phone
mobile	Mobile or cellular phone number
mail	Email address.
departmentNumber	Department

To configure LDAP via web user interface:

1. Click on **Directory** > **LDAP**.
2. Enable LDAP.
3. Enter the values in the corresponding fields according to the LDAP server settings.

The screenshot shows the Yealink T26P web interface with the 'Directory' tab selected. The 'LDAP' sub-tab is active, displaying various configuration fields. The 'Enable LDAP' dropdown is set to 'Enabled'. The 'LDAP Name Filter' is set to '(|(cn=%)(sn=%))'. The 'LDAP Number Filter' is set to '(|telephoneNumber=%)(homePhone=%)'. The 'LDAP TLS Mode' is set to 'LDAP'. The 'Server Address' is '192.168.6.218', 'Port' is '389', 'Base' is 'dc=pbx,dc=com', 'Username' is 'cn=admin,dc=pbx,dc=com', and 'Password' is masked with '*****'. 'Max Hits' is set to '50'. 'LDAP Name Attributes' is 'cn sn displayName', 'LDAP Number Attributes' is 'telephoneNumber homePhone', 'LDAP Display Name' is '%cn', 'Protocol' is 'Version 3', 'LDAP Lookup For Incoming Call' is 'Enabled', 'LDAP Lookup For Callout' is 'Enabled', and 'LDAP Sorting Results' is 'Enabled'. A 'NOTE' box on the right contains the text: 'LDAP The LDAP parameters for administrator. You can click here to get more guides.'

Figure 17-8 LDAP Settings on IP Phone

4. Click **Confirm** to accept the change.

The example configurations are set according to S-Series LDAP default settings. You can use the below settings as a starting point and adjust the filter and display attributes according to your needs.

Field	Value
LDAP Name Filter	((cn=*)(sn=*))
LDAP Number Filter	((telephoneNumber=*)(homePhone=*)(mobile=*))
Server Address	192.168.6.218 <i>/the IP of Yeastar S-Series/</i>
Port	389
Base	dc=pbx,dc=com
User Name	cn=admin,dc=pbx,dc=com
Password	***** <i>/the password you have set on Yeastar S-Series/</i>
Max. Hits	50
LDAP Name Attributes	cn sn displayName
LDAP Number Attributes	telephoneNumber homePhone mobile mail departmentNumber
LDAP Display Name	%cn
Protocol	Version 3
Search Delay(ms)(0~2000)	0
LDAP Lookup for Incoming Call	Enabled
LDAP Sorting Results	Enabled
LDAP Lookup for Pre Dial/Dial	Enabled

To configure LDAP DSS Key:

You can set a DSS key to be an LDAP key, and then press the LDAP key to enter the LDAP search screen when the IP phone is idle.

1. Click on **DssKey > Memory Key**.
2. In the desired DSS key field, select **LDAP** from the pull-down list of **Type**.
3. Click **Confirm** to accept the change.

Auto Provisioning

Yeastar S-Series supports provisioning of IP phones and Yeastar gateways in bulk. Yeastar S-Series provides two methods to do auto provisioning: PnP (Plug and Play) and DHCP.

- [Provisioning Methods](#)
- [Auto Provisioning Settings](#)

Provisioning Methods

Yeastar S-Series supports provisioning in PnP mode and DHCP mode.

- **PnP**
 1. The IP phone or VoIP gateway broadcasts SIP SUBSCRIBE message when boots up.
 2. Yeastar S-Series replies with SIP message NOTIFY and indicate the provisioning URL.
 3. The IP phone or VoIP gateway uses the path to download the configuration file, resolve and apply the configurations written in the configuration file.

NOTE:

To use PnP method, you need to enable PnP feature on your IP Phones.

- **DHCP**

Use DHCP method, you should set your SIP phone or VoIP gateway as a DHCP client and enable Yeastar S-Series DHCP server to set it as a DHCP server.

 1. The IP phone or VoIP gateway get IP address from Yeastar S-Series.
 2. Yeastar S-Series assigns an IP address and indicates the provisioning URL.
 3. The IP phone or VoIP gateway download configuration file, resolve and apply the configurations written in the configuration file.

NOTE:

To use DHCP method, you need to disable DHCP server on your router, and enable DHCP server on S-Series (System > Security > Service), ensure that S-Series is the only DHCP server in your local network.

Auto Provisioning Settings

Device List

To start with auto provisioning, you need scan devices in local network or add devices manually. All the devices will be displayed in **Device List**.

<input type="checkbox"/>	MAC Address	Extension	Name	IP Address	Manufacturer	Model	Edit	Delete
<input type="checkbox"/>	00156513210b	Not Configured	Not Configured	192.168.12.63	Yealink			
<input type="checkbox"/>	00156552789c	Not Configured	Not Configured	192.168.12.66	Yealink			
<input type="checkbox"/>	0015656502ba	Not Configured	Not Configured	192.168.12.68	Yealink			
<input type="checkbox"/>	001565341264	Not Configured	Not Configured	192.168.12.69	Yealink			
<input type="checkbox"/>	001565148155	Not Configured	Not Configured	192.168.12.70	Yealink			
<input type="checkbox"/>	0015652f716e	Not Configured	Not Configured	192.168.12.71	Yealink			
<input type="checkbox"/>	00156513216d	Not Configured	Not Configured	192.168.12.73	Yealink			
<input type="checkbox"/>	0015654a6dc3	Not Configured	Not Configured	192.168.12.75	Yealink			
<input type="checkbox"/>	0015652c4736	Not Configured	Not Configured	192.168.12.76	Yealink			
<input type="checkbox"/>	001565298bac	Not Configured	Not Configured	192.168.12.136	Yealink			

Figure 18-1 Auto Provisioning Device List

- Click **Scan** to scan all the devices in the local network.
- Click **Add** to add one device, choose the device model and fill in the device MAC address on the pop-up window.
- Click **Bulk Add** to add bulk devices, choose the devices' model and fill in their MAC addresses.

To do auto provisioning:

1. Check the box (es) before the IP phones you would like to edit, click **Edit**.

Edit Bulk Device ✕

Manufactures:

Model:

Account | Features | Preference | Codec

MAC	Line	Extension	Delete
0015657efacc	line1	1001	
00156540ae00	line1	1002	
00156533f956	line1	1003	
0015656502b4	line1	1004	

MAC: Line: Extension: **Add**

Save **Cancel**

Figure 18-2 Edit Bulk Devices

2. Choose the IP phone MAC address from the drop-down menu, and assign an extension for the phone, click **Add**. Assign extensions to other phones in the same way.
3. Click Features tab, Preferences tab and Codec tab to configure other settings for the selected phones.
4. Click **Save** to save the changes, a pop-up window appears as below. Click **Yes** and the configured phones will start to reboot to apply changes.

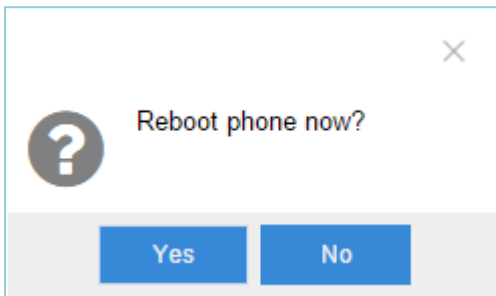

Upload Files

Users could upload phone configuration file to S-Series system, and apply the configurations to desired IP phones.

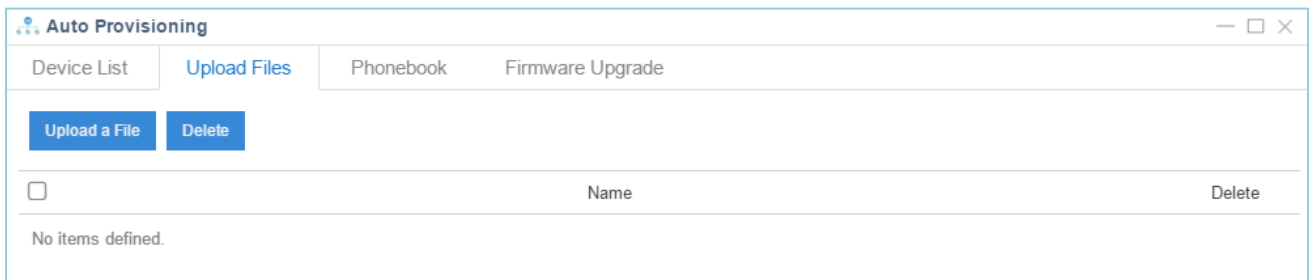

Figure 18-3 Upload Files

Click **Upload a File** to upload a phone configuration file.

Phonebook

You can add contacts on S-Series, or upload a phone book to S-Series, the phone book on S-Series will be applied to the phones during the phone provision process.

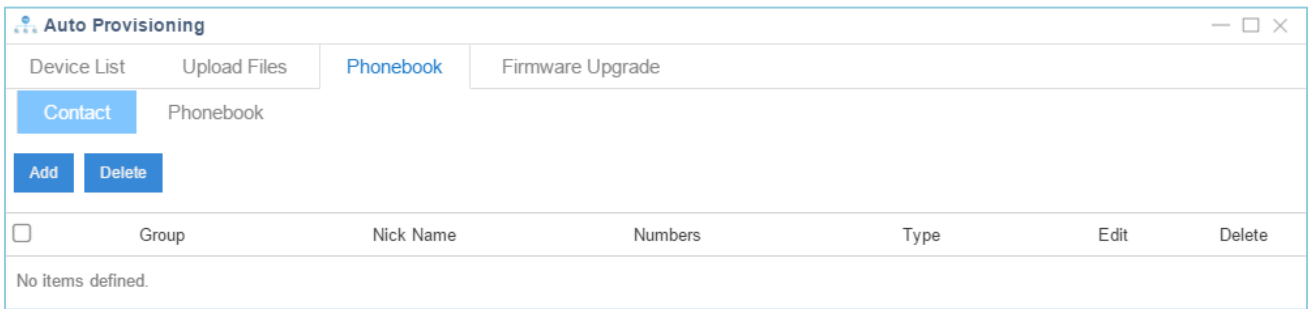

Figure 18-4 Auto Provisioning Phonebook

➤ Add Contact

Click **Add** to add contacts on S-Series. If you choose the type as “Blacklist”, the contact will be added in the blacklist. A contact in the blacklist could not call in the IP phone.

Figure 18-5 Auto Provisioning - Add Contact

➤ Upload Phonebook

Click **Upload Phonebook** to upload a phonebook to S-Series. The file format should be *.xml.

NOTE:

All the existing phonebooks of the IP phone would be deleted automatically if the phonebooks are configured in this way.

Firmware Upgrade

IP phone firmware can be uploaded to the S-Series internal storage for firmware upgrade.

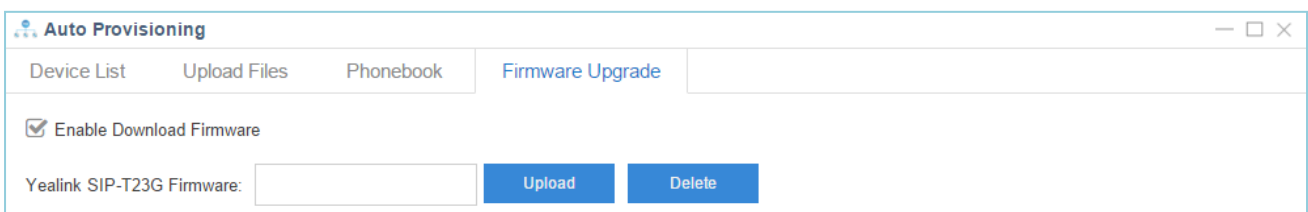
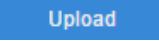

Figure 18-6 Auto Provisioning Firmware Upgrade

- Click  to upload the phone firmware file to S-Series.
- Check the box “Enable Download Firmware”, then the phone firmware will be updated during the phone provisioning process.

[END]