

Grandstream Networks, Inc.

WP820

Enterprise Portable Wi-Fi Phone

User Guide



COPYRIGHT

©2018 Grandstream Networks, Inc. <http://www.grandstream.com>

All rights reserved. Information in this document is subject to change without notice. Reproduction or transmittal of the entire or any part, in any form or by any means, electronic or print, for any purpose without the express written permission of Grandstream Networks, Inc. is not permitted.

The latest electronic version of this guide is available for download here:

<http://www.grandstream.com/support>

Grandstream is a registered trademark and Grandstream logo is trademark of Grandstream Networks, Inc. in the United States, Europe and other countries.

CAUTION

Changes or modifications to this product not expressly approved by Grandstream, or operation of this product in any way other than as detailed by this guide, could void your manufacturer warranty.

WARNING

Please do not use a different power adaptor with devices as it may cause damage to the products and void the manufacturer warranty.



FCC warning

This device complies with part 15 of the FCC Rules. Operation is subject to the following two conditions:

(1) The device may not cause harmful interference, and (2) This device must accept any interference received, including interference that may cause undesired operation.

Changes or modification not expressly approved by the party responsible for compliance could void the user's authority to operate the equipment. This equipment has been tested and found to comply with limits for a Class B digital device, pursuant to Part 15 of the FCC Rules.

These limits are designed to provide reasonable protection against harmful interference in a residential installation. This equipment generates uses and can radiate radio frequency energy and, if not installed and used in accordance with instructions, may cause harmful interference to radio communications. However, there is no guarantee that interference will not occur in a particular installation. If this equipment does cause harmful interference to radio or television reception, which can be determined by turning the equipment off and on, the user is encouraged to try to correct the interference by one or more of the following measures:

- Reorient or relocate the receiving antenna.
- Increase the separation between the equipment and receiver.
- Connect the equipment into an outlet on a circuit different from that to which the receiver is connected.
- Consult the dealer or an experienced radio/TV technician for help.

RF Radiation Exposure Statement (SAR)

This equipment complies with FCC RF radiation exposure limits set forth for an uncontrolled environment. This transmitter must not be co-located or operating in conjunction with any other antenna or transmitter.

CE Authentication

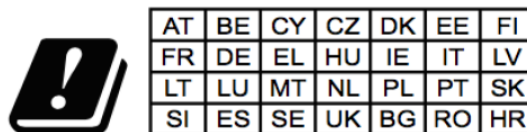

In all EU member states, operation of 5150 - 5350 MHz is restricted to indoor use only.

Hereby, Grandstream Networks, Inc. declares that the radio equipment WP820 is in compliance with Directive 2014/53/EU.

The full text of the EU declaration of conformity is available at the following internet address:
<http://www.grandstream.com/support/resources/>



SPECIFICATION

Operating Frequency Band(RF):

BT: 2402-2480MHz(TX&RX)

BLE: 2402-2480MHz(TX&RX)

2.4GHz WIFI: 2412-2472MHz(TX&RX)

5GHz WIFI: 5150-5250MHz,5250-5350MHz,5470-5725MHz(TX&RX)

Max. Of Transmit Power:

BT: 9.55dBm

BLE: 2.45dBm

2.4GHz WIFI:

802.11b:19.78dBm;802.11g:18.12dBm;

802.11n20:18.91dBm;802.11n40:18.39dBm;

5GHz WIFI:

5150-5250MHz:

802.11a:16.93dBm;802.11n20:17.49dBm;802.11n40:16.40dBm

5250-5350MHz:

802.11a:15.69dBm;802.11n20:15.53dBm;802.11n40:15.46dBm

5470-5725MHz:

802.11a:16.42dBm;802.11n20:16.63dBm;802.11n40:15.82dBm



GNU GPL INFORMATION

WP820 firmware contains third-party software licensed under the GNU General Public License (GPL). Grandstream uses software under the specific terms of the GPL. Please see the GNU General Public License (GPL) for the exact terms and conditions of the license.

Grandstream GNU GPL related source code can be downloaded from Grandstream web site from:
<http://www.grandstream.com/support/faq/gnu-general-public-license/gnu-gpl-information-download>



Table of Contents

DOCUMENT PURPOSE	12
CHANGE LOG	13
Firmware Version 1.0.1.15	13
Firmware Version 1.0.1.12	13
GUI INTERFACE EXAMPLES	14
WELCOME	15
PRODUCT OVERVIEW	16
Feature Highlights	16
Technical Specifications	16
GETTING STARTED	18
Equipment Packaging	18
Setting up the WP820	19
<i>Charging Station</i>	19
<i>Handset</i>	19
<i>Battery Information</i>	20
WP820 Handset Keys Description	20
WP820 Icons Description	22
WP820 LED Status	24
WP820 Handset Menu	24
WP820 Keypad	27
WP820 WEB GUI ACCESS CONFIGURATION	29
Configuration via Web Browser	29
<i>Accessing the Web UI</i>	29
<i>Web GUI Languages</i>	30
<i>Saving the Configuration Changes</i>	30



Web UI Access Level Management	30
<i>Changing User Level Password</i>	30
<i>Changing Admin Level Password</i>	31
<i>Changing HTTP / HTTPS Web Access Port</i>	32
BASIC OPERATIONS	34
Turning the Handset ON/OFF	34
Connecting WP820 to Wi-Fi Network	34
<i>Auto Connection</i>	34
<i>Manual connection</i>	35
Checking WP820 Status	35
<i>WP820 System Info</i>	35
<i>WP820 Network Status</i>	36
<i>WP820 SIP Account Status</i>	37
Setting the Key Lock	37
Configuring the LCD Brightness and Screen Timeout	38
Return to Idle Screen	38
Register a SIP Account	38
<i>Register Account via Web User Interface</i>	38
<i>Register Account via LCD Menu</i>	39
Guest Login	40
<i>Configuration</i>	40
<i>User Login</i>	41
<i>User Logout</i>	42
PHONE SETTINGS	43
Selecting Phone Language	43
Activate/Deactivate Hands-Free Mode	43
Muting the Microphone	43
Adjusting Speaker and Earpiece Volume	44
Ringtones	44



<i>Setting the Ringer Volume on the WP820</i>	44
<i>Setting the Ringtones on the WP820</i>	45
Date and Time	45
Reboot the WP820	46
CALL OPERATIONS	47
Placing calls	47
<i>Make a Call using a Line</i>	47
<i>Dialing from Call history</i>	48
<i>Dialing from Phonebook</i>	49
Answering Calls	49
Auto Answer	49
Ending Calls	51
Rejecting Calls	51
Call Hold/Resume	51
Call Waiting	52
Do Not Disturb	52
Call Forward	53
Call Transfer	54
Speed Dial	54
3-Way Conference	55
Voice Mail	56
<i>Set Voice Mail ID</i>	56
<i>Play Voice Mail Messages</i>	57
CALL FEATURES	59
PTT (PUSH-TO-TALK) FUNCTIONALITY	60
Enabling PTT mode on the WP820	60
Using the PTT Functionality on the WP820	61
PTT Configuration Settings	62
<i>Settings</i>	62



<i>PTT Parameters</i>	63
Group Paging	63
<i>Enabling Group Paging Feature</i>	63
<i>Group Paging Parameters</i>	65
WP820 INTELLIGENT CONTROL	67
Intelligent Control	67
UPGRADING AND PROVISIONING	68
Upgrade and Provisioning Configuration	68
<i>Configure via keypad Menu</i>	68
<i>Configure via Web GUI</i>	69
Upload Firmware Locally	69
No Local Firmware Servers	70
Firmware Upgrade via USB	70
Provisioning and Configuration File Download	71
FACTORY RESET	72
Restore to Factory Default via LCD Menu	72
Restore to Factory Default via the Web GUI	72
Restore to Factory Default using Hard Keys	73
EXPERIENCING WP820 ENTERPRISE PORTABLE WI-FI PHONE.....	74



Table of Tables

Table 1: WP820 Features at a Glance	16
Table 2: WP820 Technical Specifications	16
Table 3: Equipment Packaging	18
Table 4: WP820 Description.....	21
Table 5: WP820 Icons Description	22
Table 6: WP820 LED Status.....	24
Table 7: WP820 System Info Description.....	36
Table 8: WP820 Network Status Description	37
Table 9: WP820 System Status Description	37
Table 10: Call Features	59

Table of Figures

Figure 1: WP820 Package Content	18
Figure 2: Charging Station	19
Figure 3: WP820 Handset Setup	19
Figure 4: WP820 Description	21
Figure 5: WP820 Menu Structure	25
Figure 6: WP820 Keypad Modes	27
Figure 7: WP820 Web GUI Language	30
Figure 8: User Level Password	31
Figure 9: Admin Level Password	32
Figure 10: Web Access Port.....	33
Figure 11: Default WiFi Network	34
Figure 12: Connecting WP820 to Wi-Fi Network	35
Figure 13: System Info	35
Figure 14: WP820 Network Status.....	36
Figure 15: WP820 SIP Account Status	37
Figure 16: LCD Display Configuration	38
Figure 17: Account Status	39
Figure 18: SIP Accounts Configuration	40
Figure 19: Guest Login settings	41
Figure 20: Guest Login Window.....	42
Figure 21: Guest Logout	42
Figure 22: Configuring Phone Language	43
Figure 23: Muting the Microphone	44
Figure 24: Ringer Volume	45
Figure 25: Calls Ringtones.....	45



Figure 26: Date and Time Settings	46
Figure 27: Reboot the WP820	46
Figure 28: Dialing from Call History	48
Figure 29: Dialing from Contacts List.....	49
Figure 30: Auto-answer on WP820	50
Figure 31: Auto-answer Idle Screen.....	50
Figure 32: Hold/Unhold Calls	51
Figure 33: Calls on Hold.....	52
Figure 34: Call Waiting	52
Figure 35: DND Enabled	52
Figure 36: Call Forwarding.....	53
Figure 37: Call Transfer.....	54
Figure 38: Speed Dial Configuration	55
Figure 39: 3-way Conference Call	55
Figure 40: LCD Menu - Voice Mail ID	56
Figure 41: Web UI - Voice Mail Access Number	57
Figure 42: Playing Voicemail Messages	57
Figure 43: Voicemail Notification.....	58
Figure 44: Enabling PTT Feature on WP820.....	60
Figure 45: PPT Channel.....	61
Figure 46: PTT Call (Caller)	61
Figure 47: PTT Call (Callee)	62
Figure 48: PTT Call Release.....	62
Figure 49: Enabling Group Paging.....	64
Figure 50: Intelligent Control - Auto-answer when Leaving Charge	67
Figure 51: Intelligent Control - Auto-hang up when Entering Charging State.....	67
Figure 52: WP820 Upgrade Configuration via Keypad Menu.....	68
Figure 53: WP820 Upgrade Configuration via Web GUI	69
Figure 54: Upload Firmware File to Update	70
Figure 55: New Firmware Detected	71
Figure 56: WP820 LCD - Confirm Factory Reset.....	72
Figure 57: WP820 Web GUI - Factory Reset.....	72
Figure 58: WP820 Web GUI - Confirm Factory Reset.....	73



DOCUMENT PURPOSE

This document describes how to use WP820 Enterprise Portable Wi-Fi phone. To learn the advanced functions of WP820, please visit <http://www.grandstream.com/support> to download the latest “WP820 Administration Guide”.

This guide covers following topics:

- [Product Overview](#)
- [Getting Started](#)
- [WP820 Web GUI Access Configuration](#)
- [Basic Operations](#)
- [Phone Settings](#)
- [Call Operations](#)
- [PTT \(Push-to-Talk\) Functionality](#)
- [WP820 Intelligent Control](#)
- [Upgrading and provisioning](#)
- [Restore factory default settings](#)



CHANGE LOG

This section documents significant changes from previous firmware versions. Only major new features or major document updates are listed here. Minor updates for corrections or editing are not documented here.

Firmware Version 1.0.1.15

- Adding show storage status in System Info. [WP820 System Info]

Firmware Version 1.0.1.12

- This is the initial version for WP820.



GUI INTERFACE EXAMPLES

http://www.grandstream.com/sites/default/files/Resources/WP820_web_gui.zip

1. Screenshot of Login page
2. Screenshots of Status pages
3. Screenshots of Account pages
4. Screenshots of Phone Settings pages
5. Screenshots of System Settings pages
6. Screenshots of Maintenance pages
7. Screenshots of Application pages
8. Screenshots of Value-added Service pages



WELCOME

Thank you for purchasing Grandstream WP820. This powerful Enterprise Portable Wi-Fi Phone features dual-band 802.11a/b/g/n Wi-Fi, supports Wi-Fi roaming, and integrated Bluetooth. The combination of advanced telephony features and durability make it ideal for mobilizing your VoIP network in residences, warehouses, retail stores, hotels and many more environments. Due to a durable design, this sleek phone is drop safe from 1.2 meters, with 150 hours standby time and 7.5 hours talk time making it an ideal addition for homes and businesses alike.



PRODUCT OVERVIEW

Feature Highlights

The following table contain the major features of the WP820:

Table 1: WP820 Features at a Glance

 <p>WP820</p>	<ul style="list-style-type: none"> • 2 SIP accounts and 2 lines. • 3-way audio conference calls. • Dual-band 802.11a/b/g/n Wi-Fi. • Wi-Fi roaming and integrated Bluetooth. • 150 hours standby time. • 7.5 hours talk time. • 300m range outdoor / 50m range indoor.
---	--

Technical Specifications

The following table resumes all the technical specifications including the protocols/standards supported, voice codecs, telephony features, languages and upgrade/provisioning settings for the Base station WP820.

Table 2: WP820 Technical Specifications

Protocols/Standards	SIP RFC3261, TCP/IP/UDP, RTP/RTCP, HTTP/HTTPS, ARP, ICMP, DNS (A record, SRV, NAPTR), DHCP, SSH, TFTP, NTP, STUN, SIMPLE, TR-069, 802.1x, TLS, SRTP, IPv6
Voice Codecs and Capabilities	Support for G.711 μ /a, G.729A/B, G.722 (wide-band), iLBC, Opus, in-band and out-of-band DTMF (In audio, RFC2833, SIP INFO), VAD, CNG, AEC, PLC, AJB, AGC, ANS
Graphic Display	2.4-inch (240x320) TFT color LCD
Peripherals	3 soft keys, 3 function keys: Volume up, volume down, Push to Talk key, navigation keys, dial, hang-up, speakerphone, phonebook, backlit keypad, proximity sensor, accelerator, vibration motor
Push-to-Talk	Customizable button for push-to-talk, panic call and other related functions
Bluetooth	Yes, Bluetooth v4.2
Auxiliary Ports	3.5 mm headset jack, Micro-USB port for charging, dual-MIC, dual-color LED.



Telephony Features	Hold, transfer, forward, 3-way audio conference, downloadable phonebook (XML, up to 500 items), call waiting, call log (up to 100 records), off-hook auto dial, auto answer, click-to-dial, flexible dial plan, hot desking, personalized music ringtones and music on hold, server redundancy and fail-over, push to talk
Security	User and administrator level passwords, MD5 and MD5-sess based authentication, 256-bit AES based secure configuration file, SRTP, TLS, 802.1x media access control
HD Audio	Yes, both on handset and speakerphone with support for wideband audio, HAC supported
QoS	Layer 2 (802.1p), 802.11e and Layer 3 (ToS, DiffServ, MPLS) QoS
Multi-language	English, Arabic, Chinese, Czech, Dutch, German, French, Hebrew, Italian, Japanese, Polish, Portuguese, Russian, Spanish, Turkish and more
Upgrade/ Provisioning	Firmware upgrade via TFTP/HTTP/HTTPS, manual upload, mass provisioning using TR-069 or encrypted XML configuration file, manual upload, USB upgrade
Power & Green Energy Efficiency	Universal power adapter included Input: 100-240VAC; Output: +5VDC, 1A (5W) 1500mA Li-ion battery, 150h standby time and 7.5h talk time
Physical	Handset Dimensions: 168.5 x 52.5 x 21.8mm Charger cradle dimensions: 76 x 73 x 81mm Handset weight: 161g Handset package weight (not including QIG): 456g
Temperature and Humidity	Operating Temperature: 0~45°C; Operating Humidity: 10~90%(non-condensing) Storage Temperature: -20~60°C; Storage Humidity: 10~90%(non-condensing)
Package Contents	Handset unit, universal power supply, charger cradle, belt clip, 1 Li-ion battery, Quick Installation Guide.
Durability	Drop-safe from 1.2 meters height
Compliance	FCC, CE, RCM



GETTING STARTED

This chapter provides basic installation instructions including the list of the packaging contents and also information for obtaining best performance with the WP820.

Equipment Packaging

Table 3: Equipment Packaging

WP820
<ul style="list-style-type: none"> • 1x Handset unit • 1x Universal power supply 5V • 1x Charger cradle • 1x Belt clip • 1x Rechargeable battery • 1x Quick Installation Guide • 1x GPL Statement

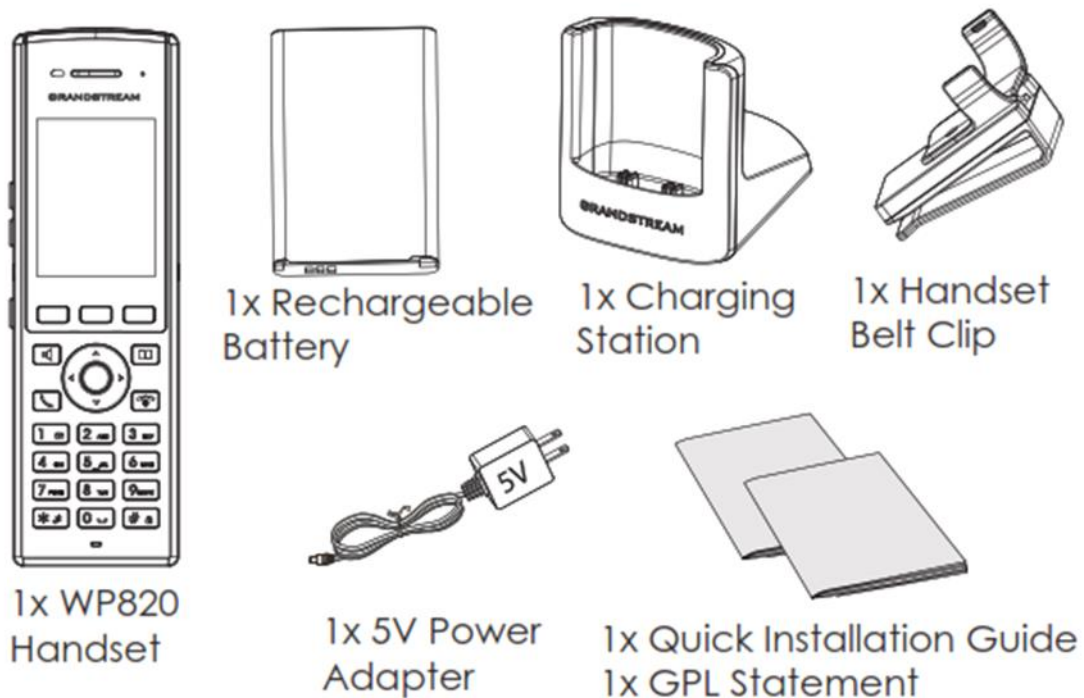

Figure 1: WP820 Package Content

Note: Check the package before installation. If you find anything missing, contact your system administrator.

Setting up the WP820

Charging Station

Plug the power adapter into a power source socket to start using the charging station.

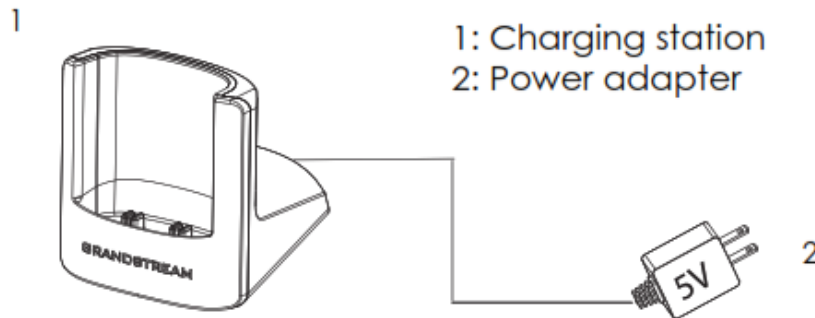

Figure 2: Charging Station

Handset

Please refer to the following steps in order to setup your WP820:

1. Open the battery cover.
2. Insert the battery with the electrodes in the bottom left corner.
3. Close the battery cover.

Note: Please charge the battery fully before using the handset for the first time. (For more information about the battery, please refer to [Battery Information](#).)

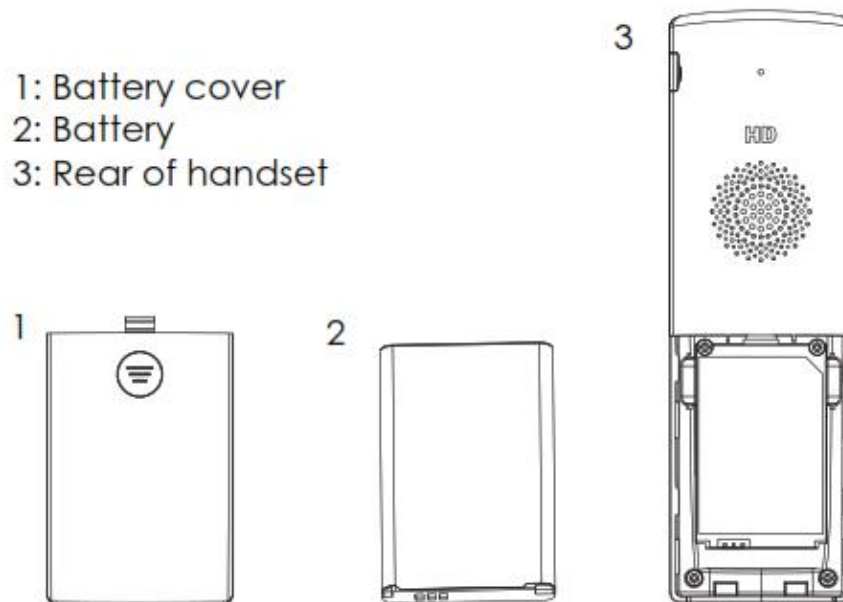

Figure 3: WP820 Handset Setup

Battery Information

- **Technology:** Rechargeable Li-ion Battery
- **Voltage:** 3.8V (Nominal Voltage 3.8V / Limited charge Voltage: 4.35 V)
- **Capacity:** 1500mAh
- **Standby time:** up to 150 hours
- **Talk time:** up to 7.5 hours' active talk time

In order to get the best performance of your WP820, we recommend using original battery provided in the package. The specifications may differ depending on the age and capacity of the battery used.

Important Note: Be careful when inserting the battery into your handset to avoid any risk of short-circuit, which lead to damage your battery and/or the handset itself. Do not use damaged batteries which can increase the risk of serious harm.

WP820 Handset Keys Description

The WP820 enhances communication and combines usability and scalability in industries such as warehousing, catering and retail as well as in factory settings. The following screenshot describe the WP820 LCD screen and the main hardware components.



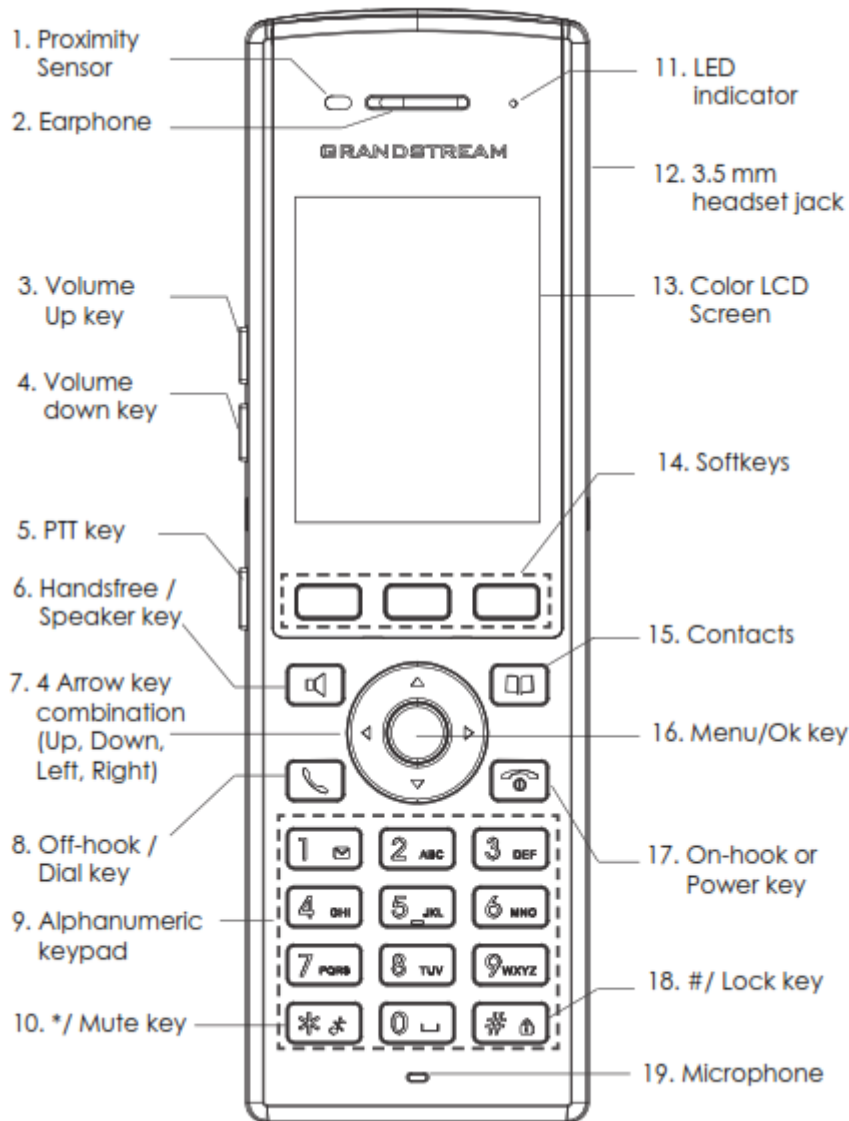

Figure 4: WP820 Description

The following table describe the WP820 keypad keys.

Table 4: WP820 Description



	Key	Description
1.	Proximity sensor	The proximity sensor can detect the presence of a human ear. This sensing is done for two purposes: Reduce display power consumption by turning off the LCD backlight and to avoid inadvertent touches.
2.	Earphone	Delivers audio output.
3,4	Volume up / Down Keys	Configure the handset and ringtone volume.



















5.	PTT Key	PTT (Push-to-Talk) button to initiate PTT call.
6.	Hands-free / Speaker key	Switches between Handset and Hands-free / Speaker modes.
7.	Arrow key combination (Up, Down, Left, Right)	Allows navigation of the cursor through the displayed menu options.
8.	Off-hook / Dial key	Enters dialing mode, or dials number entered.
9.	Alphanumeric Keypad	Provides the digits, letters, and special characters in context-sensitive applications. For + sign, press and hold key 0.
10.	* / Mute key	Activates or deactivates the mute feature when keep pressing on * in idle screen.
11.	LED indicator	1dual-color LED indicator indicating: power, call, battery, message waiting ...
12.	3.5 mm headset jack	Phone connector for the headphones/headsets.
13.	Color LCD Screen	2.4-inch (240x320) TFT color LCD
14.	Softkeys	Correspond to functions displayed on the LCD. These functions change depending on the current context.
15.	Contacts	Access to contacts list.
16.	Menu/OK key	Selects the option chosen by the cursor or enters the main menu from the home screen.
17.	On-hook or Power key	Terminates calls or turns the handset on / off.
18.	# / Lock key	Locks keypad against unintentional entries when keep pressing #. <ul style="list-style-type: none"> • Press and hold # key for approximately 2 seconds to lock the keys. • Press Unlock softkey and then # to unlock the keys.
19.	Microphone	Picks up audio earpiece and hands-free calls.

WP820 Icons Description

Following table contains description of each icon that might be displayed on the screen of the WP820.

Table 5: WP820 Icons Description

	Battery status Charging
	Wi-Fi not enabled/configured
	Wi-Fi signal status

	Speaker enabled icon
	Ringtone status
	Outgoing Call notification
	Missed Call notification
	Incoming Call notification
	Voicemail notification (Urgent)
	Voicemail notification (Ordinary)
	Mute enabled icon
	DND enabled icon
	Bluetooth enabled icon
	Bluetooth connected icon
	Contacts
	SMS
	Call History
	Voice Mail
	Diagnosis
	Settings
	Tools
	Status

WP820 LED Status

Table 6: WP820 LED Status

Red Fast Flashing	<ul style="list-style-type: none"> • Upgrading
Green Slow Flashing	<ul style="list-style-type: none"> • Incoming call
Green Blinking	<ul style="list-style-type: none"> • Charging but not full
Green Solid	<ul style="list-style-type: none"> • Charging (full)
Red Slow Flashing	<ul style="list-style-type: none"> • Missed call (s) • New voicemail (s) • New SIP Message (s)
Red Solid	<ul style="list-style-type: none"> • Network disconnected
LED OFF	<ul style="list-style-type: none"> • Normal

WP820 Handset Menu

The handset has an easy-to-use menu structure. Every menu opens a list of options. To open the main menu, unlock first the handset and press “Menu” (softkey in the middle). Press Arrow keys to navigate to the menu option you require. Then press “Select” (left softkey) or **OK/Selection key** to access further options or confirm the setting displayed.

To go to the previous menu item, press “Back” (right softkey). You can press **Power** key at any time to cancel and return to standby mode.



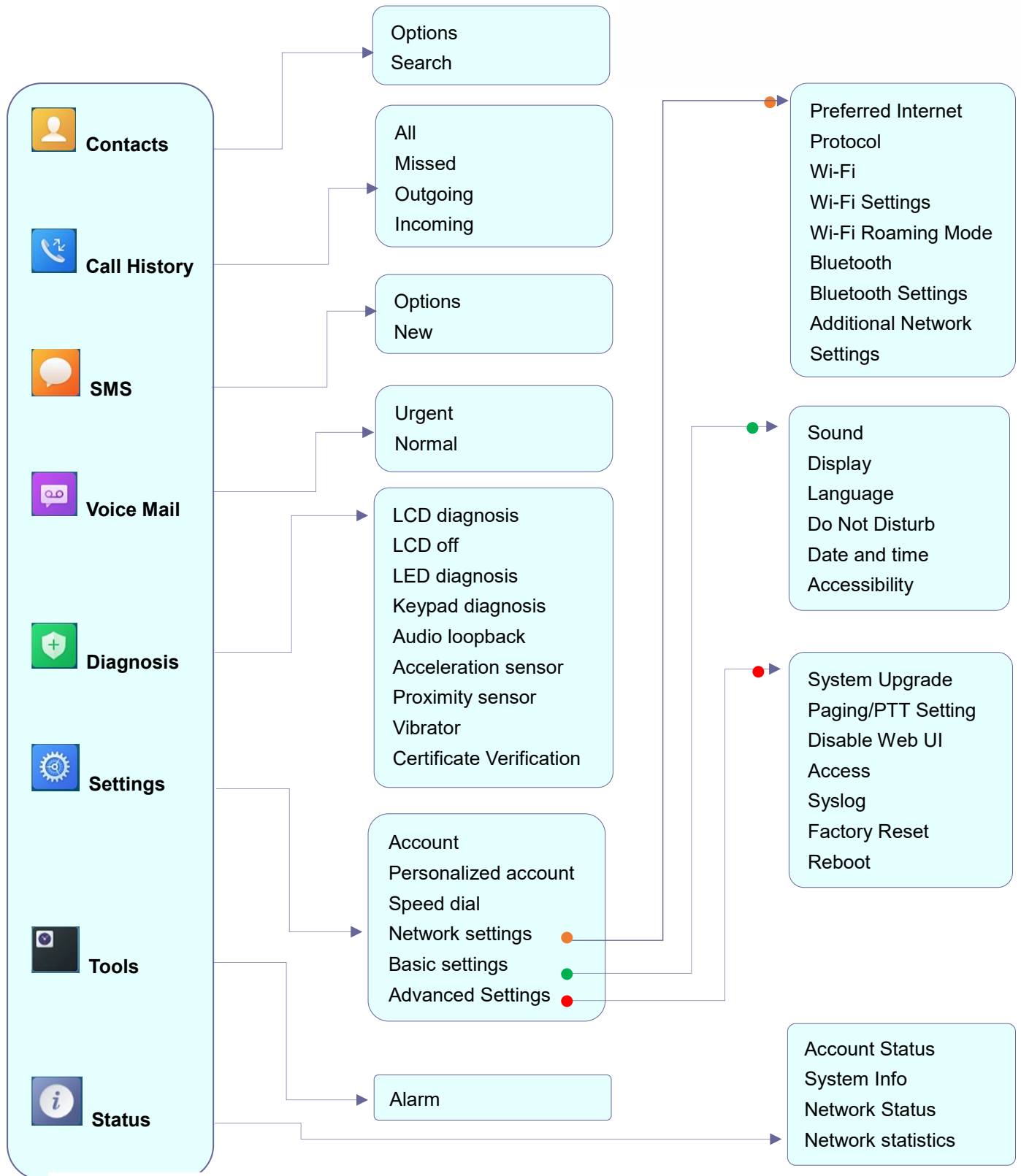

Figure 5: WP820 Menu Structure



Contacts	Display the list of the registered contacts and also the groups contacts with the ability of searching, adding or editing the entries and also deleting the selected contacts.
Call History	Display the call history: Missed Calls , Accepted Calls , Outgoing Calls or All Calls . You can add contacts to Shared Contacts directly from call logs.
SMS	SMS stands for Short Message Service and referred to as a "text message". With a SMS, you can send a message by pressing " New " of up to 160 characters to another device or check the received ones.
Voice Mail	<ul style="list-style-type: none"> • Play Message: Play voice mail messages received. • Set Voice Mail: Configure voice mail parameters.
Diagnosis	<ul style="list-style-type: none"> • LCD diagnosis • LCD off • LED diagnosis • Keypad diagnosis • Audio loopback • Acceleration sensor • Proximity sensor • Vibrator • Certificate Verification
Settings	<ul style="list-style-type: none"> • Account Configure/View SIP accounts settings. • Personalized Account Configure the account ringtones, auto answer and call forwarding. • Speed Dial Assign contact numbers as speed dial. • Network Settings Configure the networks settings including Wi-Fi settings, Bluetooth settings, and additional networks settings. • Basic Settings Configure the basic settings including voice settings, display and language settings, date/time settings and accessibility. • Advanced Settings Configure the advanced settings including system upgrade, paging/PTT settings, syslog settings and factory reset / reboot.
Tools	<ul style="list-style-type: none"> • Alarm Clock Configures the alarm clock settings



Status	Displays account status, system info, Network status and network statistics <ul style="list-style-type: none"> • Account status. • System Info: Press to enter the sub menu for Running memory, Storage status, MAC address, System version, Recovery version, U-boot version, Kernel version, Hardware version, PN number, Country code and Running time. • Network status: Press to enter the sub menu for MAC address, IP setting information (DHCP/Static IP), IPv4 address, IPv6 address, Subnet Mask, Gateway; DNS server and VPN. • Network Statistics: Press to enter the sub menu for Network SSID, BSSID, IP address, Signal strength, Connection speed, Channel, Frequency, Tx packets, Tx error packets, Tx error rate, Tx drop packets, Tx drop rate, Rx packets, Rx error packets, Rx error rate, Rx drop packets, Rx drop rate.
---------------	--

WP820 Keypad

The WP820 keypad can be used by tapping on an input field. WP820 keypad has 4 modes “ABCabc2”, “ABC”, “abc” and “123”. Default mode is “ABCabc2”. **Note:** If the input field is accepting only digits, only “123” mode will be available.

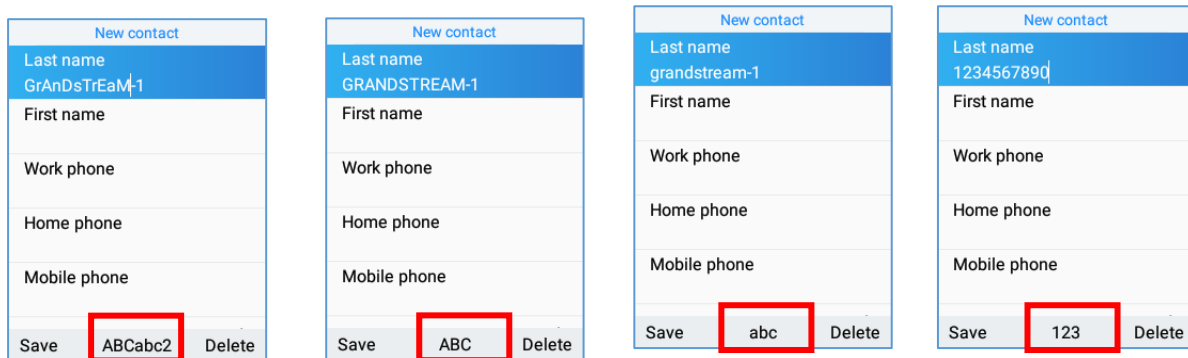

Figure 6: WP820 Keypad Modes

- **“ABCabc2” Mode:**

This mode allows to enter capital letters, small letters, digits and symbolic characters.

Following table describes allowed characters for each key.

Key	Description	Key	Description	Key	Description
1	. , ' ? ! " - 1	2	A B C a b c 2	3	D E F d e f 3
4	G H I g h i 4	5	J K L j k l 5	6	M N O m n o 6
7	P Q R S p q r s 7	8	T U V t u v 8	9	W X Y Z w x y z 9
*	. , ' ? ! " - () @ / : _ ; + % * = < > \$ [] { } \ ~ ^ # ` &	0	Space	#	Switch mode



- **“ABC” Mode:**

This mode allows to enter capital letters, digits and symbolic characters.

Following table describes allowed characters for each key.

Key	Description	Key	Description	Key	Description
1	. , ' ? ! " - 1	2	A B C 2	3	D E F 3
4	G H I 4	5	J K L 5	6	M N O 6
7	P Q R S 7	8	T U V 8	9	W X Y Z 9
*	. , ' ? ! " - () @ / : _ ; + % * = < > \$ [] { } \ ~ ^ # ` &	0	Space	#	Switch mode

- **“abc” Mode:**

This mode allows to enter small letters, digits and symbolic characters.

Following table describes allowed characters for each key.

Key	Description	Key	Description	Key	Description
1	. , ' ? ! " - 1	2	a b c 2	3	d e f 3
4	g h i 4	5	j k l 5	6	m n o 6
7	p q r s 7	8	t u v 8	9	w x y z 9
*	. , ' ? ! " - () @ / : _ ; + % * = < > \$ [] { } \ ~ ^ # ` &	0	Space	#	Switch mode

- **“123” Mode:**

This mode allows to enter digits and . only.

Following table describes allowed characters for each key.

Key	Description	Key	Description	Key	Description
1	1	2	2	3	3
4	4	5	5	6	6
7	7	8	8	9	9
*	.	0	0	#	Switch mode

Tips using the keypad:

- To switch between the modes, users could press the middle softkey or # key.
- Press multiple times on same key to move forward between the allowed characters.
- Use Right/Left arrow keys to change the cursor's position on the text entered.



WP820 WEB GUI ACCESS CONFIGURATION

The WP820 can be configured using:

- Web GUI embedded on the WP820 using PC's web browser.
- LCD Configuration Menu using the WP820 keypad.

Note: From the Web GUI, you can configure all the functions supported by the WP820; while via keypad menu, you can access limited configuration.

Configuration via Web Browser

The WP820 embedded Web server responds to HTTP/HTTPS GET/POST requests. Embedded HTML pages allow a user to configure the WP820 through a Web browser such as Google Chrome, Mozilla Firefox.

Note: Please note that Microsoft's IE 9 and below are not supported, also the records from the web can't be played with IE10, Edge and Safari. We highly recommend using Google Chrome or Mozilla Firefox.

Accessing the Web UI

1. Connect the computer to the same network as WP820.
2. Make sure the WP820 is booted up and powered correctly.
3. You may check WP820 IP address via a subscribed WP820 on its LCD menu **Settings** → **Network Status**. Please see [\[WP820 Network Status\]](#)
4. Open Web browser on your computer and enter the WP820 IP address in the address bar of the browser.
5. Enter the administrator's username and password to access the Web Configuration Menu.

Notes:

- The computer must be connected to the same sub-network as the WP820. This can be easily done by connecting the computer to the same hub or switch as the WP820.
- The default administrator username and password are "admin"; the default end-user username is "user" and the password is "123".



Web GUI Languages

Currently the WP820 web GUI supports English, Chinese languages.

Users can select the displayed language in web GUI login page, or at the upper right of the web GUI after logging in

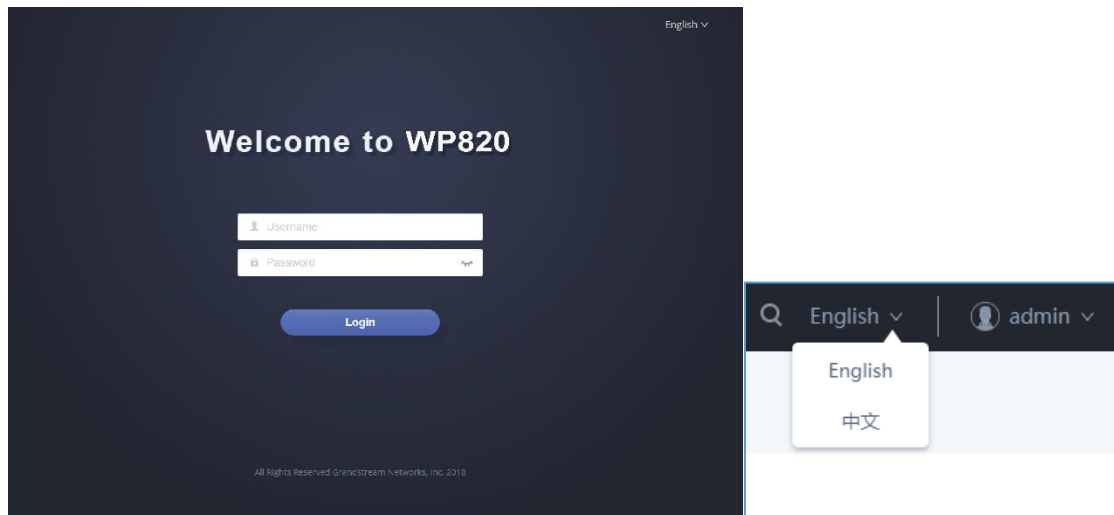

Figure 7: WP820 Web GUI Language

Saving the Configuration Changes

When changing any settings, always submit them by pressing **Save** and **Apply** buttons. If using the **Save** button, after making all the changes, click on the **Apply** button on top of the page to submit.

Web UI Access Level Management

There are two default passwords for the login page:

User Level	Username	Password	Web Pages Allowed
End User Level	user	123	Only Status, Phone Settings, System Settings, Maintenance and System Application with limited options.
Administrator Level	admin	admin	All pages

Changing User Level Password

1. Access the Web GUI of your WP820 using the admin's username and password. (Default username and password is: admin/admin).
2. Press **Login** to access your settings.
3. Go to **System Settings** → **Security Settings**.



4. In **User Info Management**, locate **user password** section:
 - a. Type in the admin password in the **Current Admin Password** field.
 - b. Type in your new user password in **New User Password** field.
 - c. Type in again same entered password in **Confirm New User Password** field.
5. Press **Save** and **Apply** buttons to save your new settings.

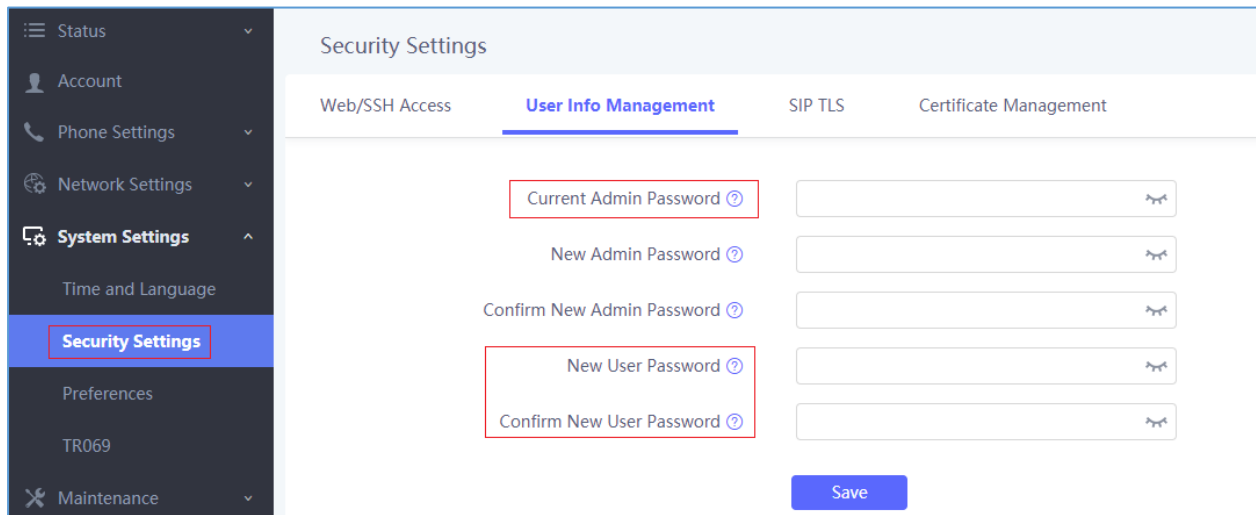

Figure 8: User Level Password

Notes:

- DO NOT USE same password for both user and admin accounts.
- The password is case sensitive with maximum length of 25 characters.

Changing Admin Level Password

1. Access the Web GUI of your WP820 using the admin's username and password. (Default username and password is: admin/admin).
2. Press **Login** to access your settings.
3. Go to **System Settings** → **Security Settings**.
4. In **User Info Management**, locate **admin password** section:
 - a. Type in the admin password in the **Current Admin Password** field
 - b. Type in your new user password in **New Admin Password** field.
 - c. Type in again same entered password in **Confirm New Admin Password** field.
5. Press **Save** and **Apply** buttons to save your new settings.

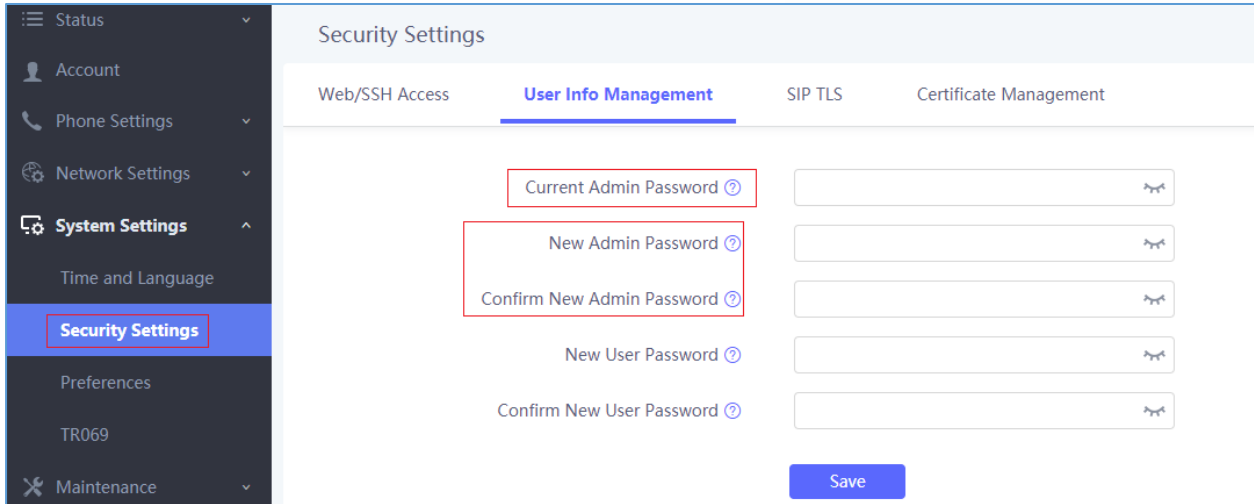

Figure 9: Admin Level Password

Notes:

- DO NOT USE same password for both user and admin accounts.
- The password is case sensitive with maximum length of 25 characters.

Changing HTTP / HTTPS Web Access Port

1. Access the Web GUI of your WP820 using the admin’s username and password. (Default username and password is: admin/admin).
2. Press **Login** to access your settings.
3. Go to **System Settings** → **Security Settings**.
4. In **Web/SSH Access** page, select the access method depending on desired protocol (HTTP or HTTPS)
5. Locate **HTTP / HTTPS Web Port** field and change it to your desired/new HTTP / HTTPS port.
Note: By default, the HTTP port is 80 and HTTPS is 443.
6. Press **Save** and **Apply** buttons to save your new settings.

Note: A reboot is required for this change to take effect.

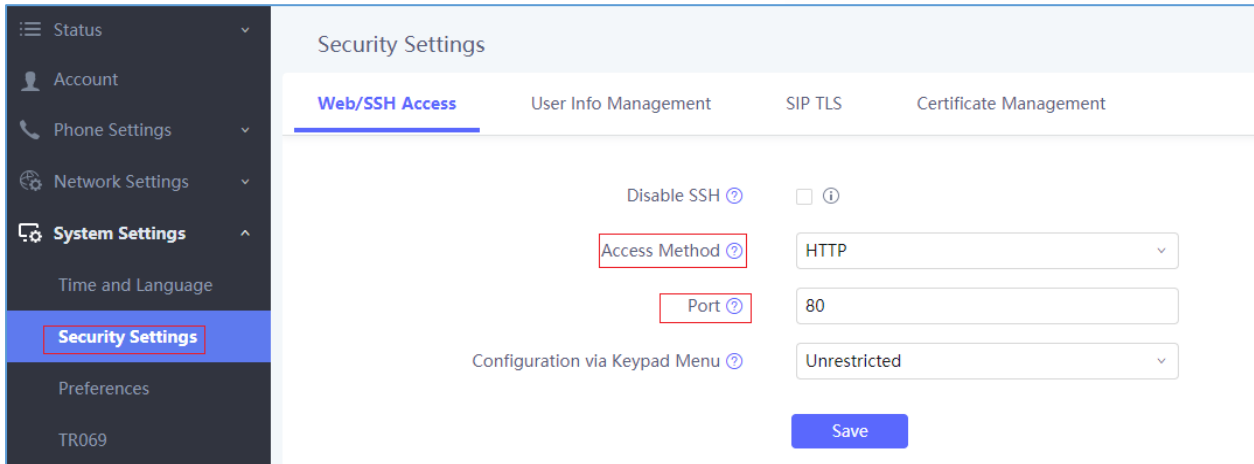

Figure 10: Web Access Port

BASIC OPERATIONS

Turning the Handset ON/OFF

To turn ON the handset

- Long press on **Power key**  until the LCD screen lights up.

To turn OFF the handset

- Long press on **Power key**  again when the handset is idle and press the softkey to choose to power off or reboot.

Connecting WP820 to Wi-Fi Network

Auto Connection

For easy deployment, WP820 out of the box is preconfigured to connect to a default SSID named **wp_master** with a password (WPA/WPA2 PSK) equal to **wp!987@dmin**, users can adapt these settings from the web UI as well to make it easier for deployment on customer site.

Go under the web interface of the “**Network Settings → Wi-Fi Settings → Wi-Fi Security**”.

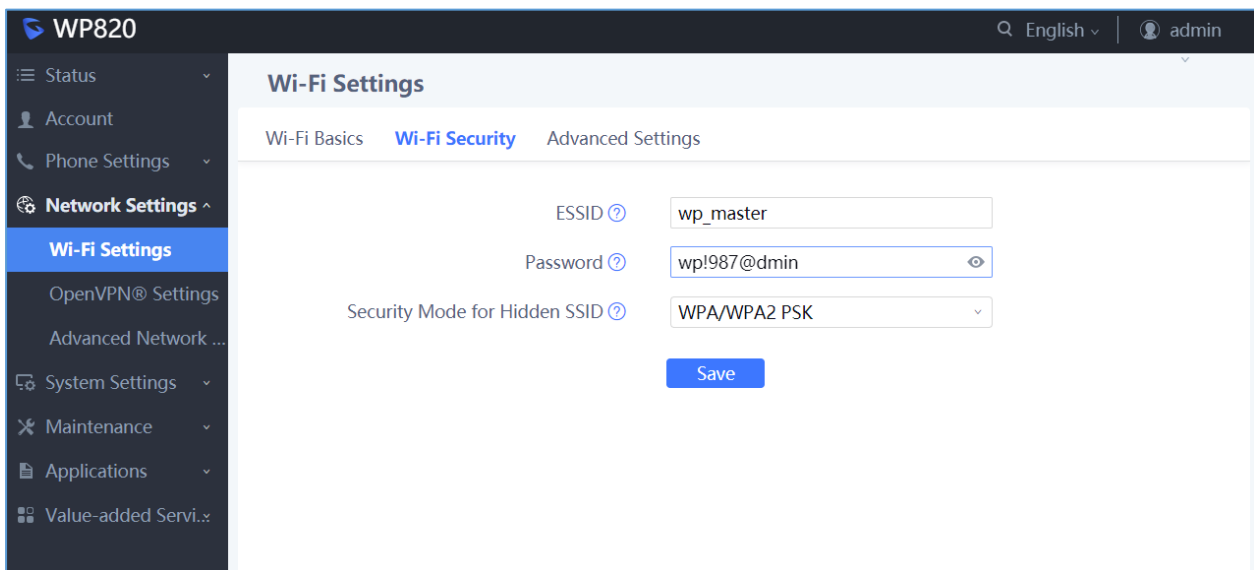

Figure 11: Default WiFi Network

For example, the user can pre-configure the WP to automatically connect to the WiFi network at the client site, making it easier for the client to use the phone without going through the setting up manually the Wi-Fi network. Also, the client could have the SSID hidden by default, and the WP820 handset would still be able to connect to the Wi-Fi network since they have SSID and password information configured.

Manual connection

The WP820 supports dual-band 802.11a/b/g/n Wi-Fi, please refer to the following steps in order to connect your WP820 to the Wi-Fi networks:

1. On LCD menu, press Menu key and navigate to **Settings** → **Network Settings** → **Wi-Fi**.
2. Set Wi-Fi to “On” and navigate to “Wi-Fi Settings“. A list of Wi-Fi networks will be displayed.
3. Select the desired network to connect to. (Enter the correct password to connect if requested)

WP820 will display Wi-Fi icon on the main LCD menu if the connection to the Wi-Fi network is successful.

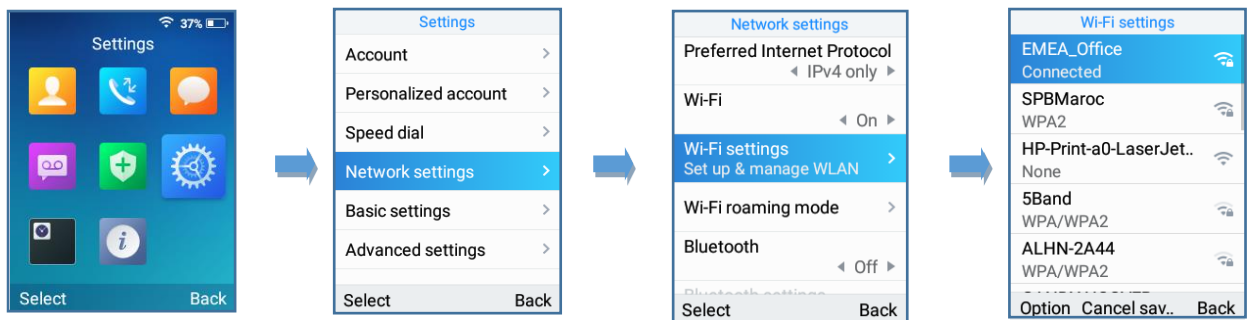

Figure 12: Connecting WP820 to Wi-Fi Network

Note: If 5GHz and 2.4GHz are both available, the WP820 will use 5GHz, but it may switch to 2.4GHz if the signal of 5GHz is poor.

Checking WP820 Status

WP820 System Info

To check the system info, follow these steps:

1. Press **Menu** key to bring up operation menu
2. Use arrow keys to reach **Status** menu and navigate to **System Info** section.

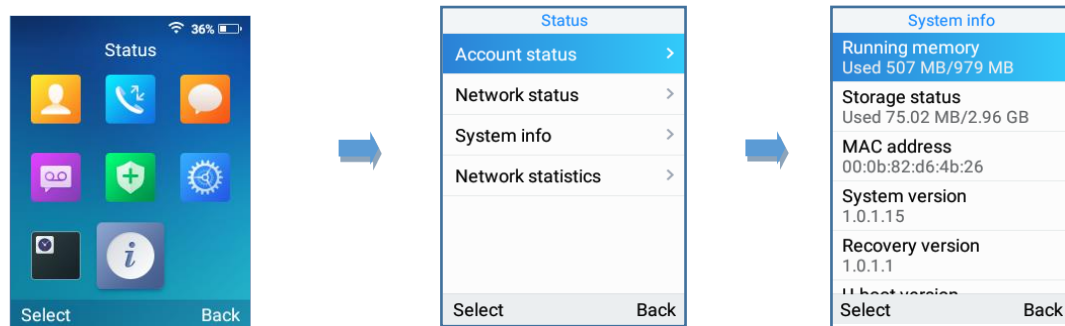

Figure 13: System Info



The following information will be displayed:

Table 7: WP820 System Info Description

Item	Description
Running Memory	Displays information about the memory.
Storage Status	Displays information about the storage space on the phone.
MAC Address	Displays the MAC Address of the phone.
System Version	Displays the current firmware version installed.
Recovery Version	Displays the recovery version installed.
U-boot Version	Displays the u-boot version installed.
Kernel Version	Displays the kernel version installed.
Hardware Version	Displays the hardware version installed.
PN Number	Displays the Part Number.
Country code	Displays the country code.
Running Time	Displays the time during which the WP820 is powered on and working.

WP820 Network Status

To check the handset network information status, follow these steps:

1. Press **Menu** key to bring up operation menu.
2. Use arrow keys to reach **Status** menu and navigate to **Network Status**.

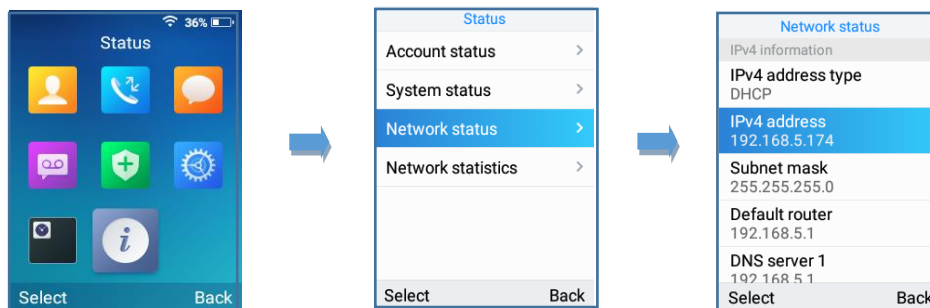

Figure 14: WP820 Network Status

The following information will be displayed:

Table 8: WP820 Network Status Description

Item	Description
IPv4 Information	Displays the information about IPv4 address type, IPv4 address, subnet mask, default router and DNS servers.
IPv6 Information	Displays the information about IPv6 address type, IPv6 address, and DNS servers.
Other Network Information	Displays the MAC address of the handset and also the NAT type.

WP820 SIP Account Status

To check the SIP accounts status, follow these steps:

1. Press **Menu** key to bring up operation menu.
2. Use arrow keys to Reach **Status** menu and navigate to **Account status**.

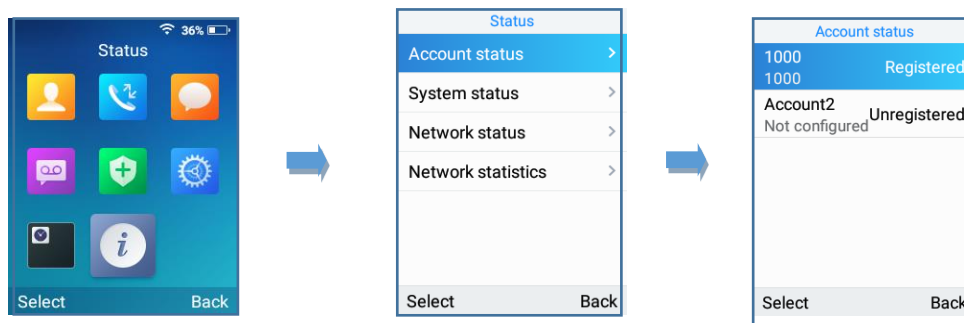
Figure 15: WP820 SIP Account Status

The following information will be displayed:

Table 9: WP820 System Status Description

Item	Description
Account 1	Displays the information about the first account including name, number and the status of its registration.
Account 2	Displays the information about the second account including name, number and the status of its registration.

Setting the Key Lock

- **To enable the Keypad Lock**

- Press the **Pound key “#”** and hold for approximately 2 seconds, or
- Press **On-hook / power key** while the LCD is idle.

- **To disable the Keypad Lock**

- Press **Unlock** button (Left softkey) and **Pound key “#”** to unlock the keys.

Note: When the phone is locked, it is still possible to pick up incoming calls.

Configuring the LCD Brightness and Screen Timeout

1. Press **Menu** to bring up operation menu.
2. Use arrow keys to reach **Settings**.
3. Navigate to **Basic Settings**, and then select **Display**.
4. Configures the LCD brightness, key backlight, lock screen, screen time out and the font size.
5. Press “**Back**” (right softkey) to save and apply the new settings.

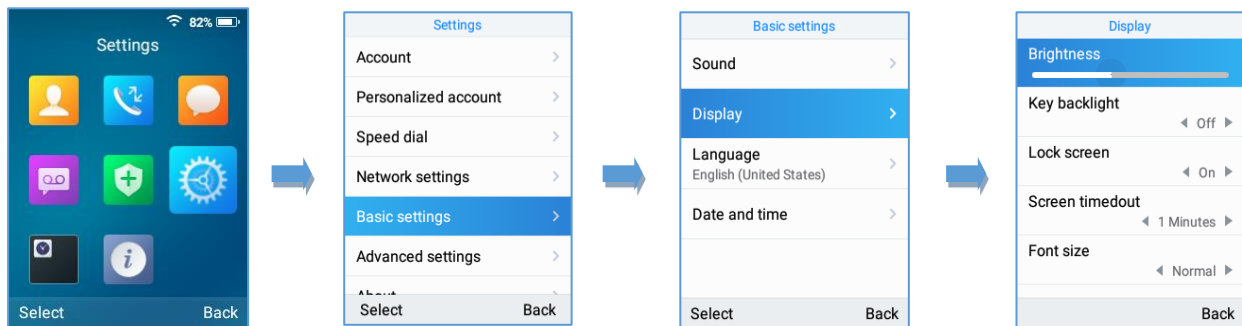



Figure 16: LCD Display Configuration

Return to Idle Screen

Press the **Power Key**  to quickly exit the menu and return back to the main idle screen.

When you are navigating on the handset’s menu, and you receive an incoming call, the LCD screen will automatically exit the menu and you can either accept or reject the call, when the call is terminated, the LCD screen will return back to the idle screen.

Register a SIP Account

The WP820 supports up to 2 SIP accounts and they can be configured either using the web GUI or via the keypad menu as described on the following section.

Register Account via Web User Interface

1. Access your WP820 base station web UI by entering its IP address in your favorite browser.
2. Enter your admin’s username and password (default username and password: admin/admin).



3. Press **Login** to access your settings.
4. Go to **Account** tab and select the account to configure.
5. In **General Settings**, set the following:
 - a. **Account Active** to **Yes**.
 - b. **Account Name**: Any name to identify this specific user.
 - c. **SIP Server** field with your SIP server IP address or FQDN.
 - d. **Secondary SIP Server** with your secondary SIP server IP address or FQDN. Leave empty if not available.
 - e. **SIP User ID**: User account information, provided by VoIP service provider (ITSP). Usually in the form of digit similar to phone number or actually a phone number.
 - f. **SIP Authenticate ID**: SIP service subscriber's authenticate ID used for authentication. Can be identical to or different from SIP User ID.
 - g. **SIP Authentication Password**: SIP service subscriber's account password to register to SIP server of ITSP. For security reasons, the password will field will be shown as empty.
 - h. **Outbound Proxy** with your outbound proxy IP address or FQDN. Leave empty if not available.
6. Press **Save and Apply** to save your configuration.

After applying your configuration, your phone will register to your SIP Server. You can verify if your WP820 has registered with your SIP server from its web interface under **Status** → **Account Status** (“**Registered**” with green color when the account is correctly registered, or “**Unregistered**” with grey when the account is not properly registered)

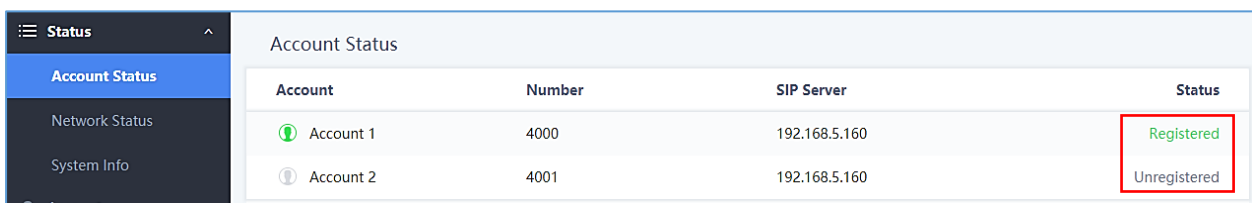

Account Status			
Account	Number	SIP Server	Status
Account 1	4000	192.168.5.160	Registered
Account 2	4001	192.168.5.160	Unregistered

Figure 17: Account Status

Register Account via LCD Menu

To register your SIP account via the LCD menu, please refer to following steps:

1. Unlock your WP820 and press **Menu** to bring up operation menu.

2. Use arrow keys to reach **Settings** and then select **Account** tab.
3. Select which account you want configure and then set the following:
 - a. **Account Activation** to “On”.
 - b. **Account Name:** Any name to identify this specific user.
 - c. **SIP Server** field with your SIP server IP address or FQDN.
 - d. **SIP User ID:** User account information, provided by VoIP service provider (ITSP). Usually in the form of digit similar to phone number or actually a phone number.
 - e. **SIP Authenticate ID:** SIP service subscriber’s authenticate ID used for authentication. Can be identical to or different from SIP User ID.
 - f. **SIP Authentication Password:** SIP service subscriber’s account password to register to SIP server of ITSP. For security reasons, the password will field will be shown as empty.
 - g. **Voicemail Access Number:** The voicemail number of your account.
 - h. **Display Name:** The name that will be used for caller ID name in SIP INVITE.

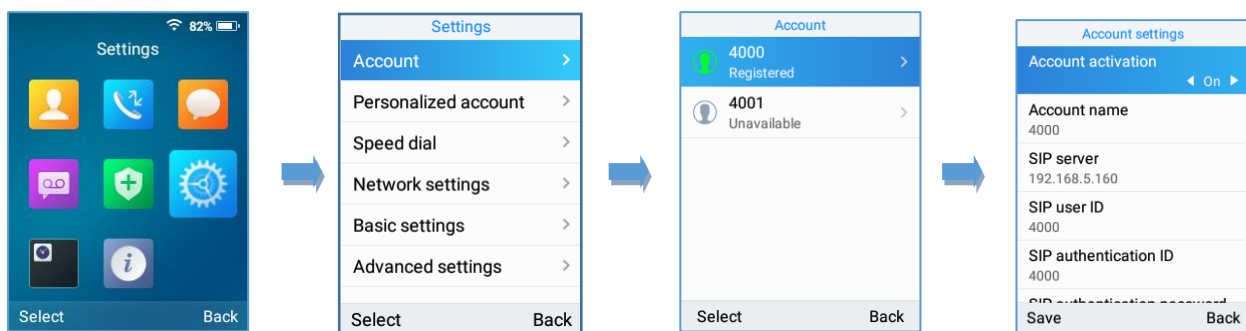

Figure 18: SIP Accounts Configuration

Guest Login

The Guest Login feature provides the ability to share the same wireless phone by multiple users at different periods of time.

Configuration

This feature can be enabled from the WEB GUI under **General Settings** → **Guest Features**.



General Settings

Basic Settings
Guest Features

Guest Settings

Guest Login ? i

Guest Login PIN Code ?

Save

SIP Domain

Server Alias ?

Server List ? +

Add
Cancel

Figure 19: Guest Login settings

1. Enable the Guest login by checking the Guest Login parameter.
2. Enter the PIN to be used for authentication.
3. Configure the SIP domain to be used as SIP server for registration:
 - a. Server Alias: The server alias is used to customize the server name.
 - b. The Server list will contain the IP addresses/Domain names to be used as SIP registration servers

Note: A reboot is required for these settings to take effect.

User Login

Once the phone boots up with the Guest Login feature enabled users can follow these steps to login:

1. Press the dial button or press any numeric button.
2. The Guest Login page will be opened, and the user is asked to enter the Extension credentials.
3. Enter the Account ID, the SIP password and choose the Alias of the SIP server configured on the WEB GUI as mentioned on steps above.



4. Set the “Expire parameter” to the number of hours this login will stay valid.

Guest login	
Account name	1003
Password	
SIP domain	◀ Server 1 ▶
Expire	◀ Always ▶
PIN code	
Login	Back

Figure 20: Guest Login Window

Note: When the “Expire” parameter is set to “Always” users are asked to enter the PIN code that was previously configured on the WEB GUI.

User Logout

To logout from the Guest Login mode users can follow these steps:

1. On idle screen, press the **Settings** soft-key.
2. Select **Logout**.
3. Confirm the logout by pressing the **Logout** soft-key.

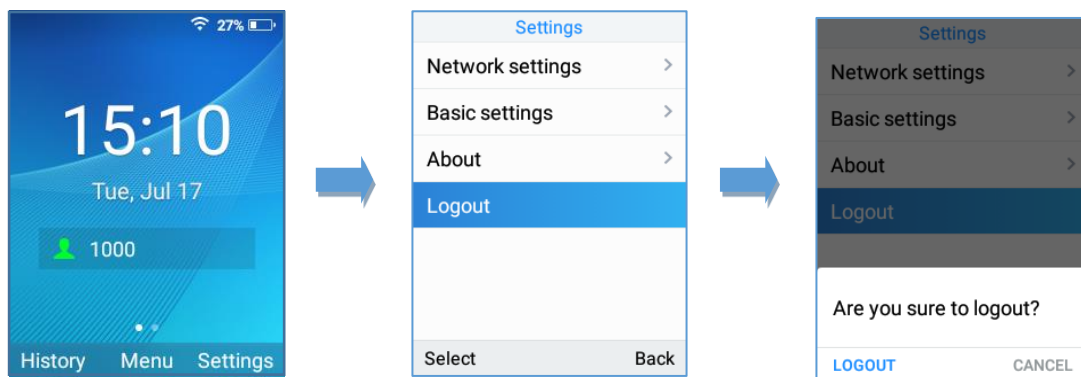

Figure 21: Guest Logout

PHONE SETTINGS

Selecting Phone Language

The WP820 supports different languages. The default language of the handset is English. To change the language of the handset, please proceed as follows:

1. Press **Menu** to bring up operation menu.
2. Use arrow keys to reach **Settings**.
3. Navigate to **Basic Settings**, and then select **Language**.
4. Choose the desired language from the available list and press “**Select**” and then the phone will apply the selected language.

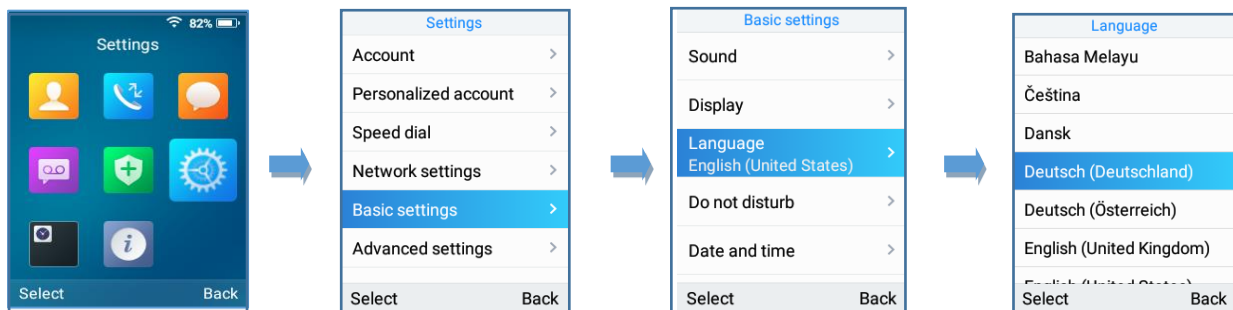



Figure 22: Configuring Phone Language

Activate/Deactivate Hands-Free Mode

- Press the **Hands-free key**  while making a call or on the idle screen to activate hands free mode.
- Press the **Hands-free key**  again to deactivate the hands-free function.

Muting the Microphone

1. Press the button “**Options**” (**Left softkey**) during an established call and a list of the options will be displayed.
2. Choose” **Mute**” and press “**Select**” button (left softkey / OK button) to switch on the microphone.

Notes:

- While muted, the icon  will be displayed on the screen.



- To unmute the microphone during an established call, press the button “**Options**” (Left softkey), choose “**Unmute**” and press “**Select**” button (left softkey or OK button) to switch off the microphone.

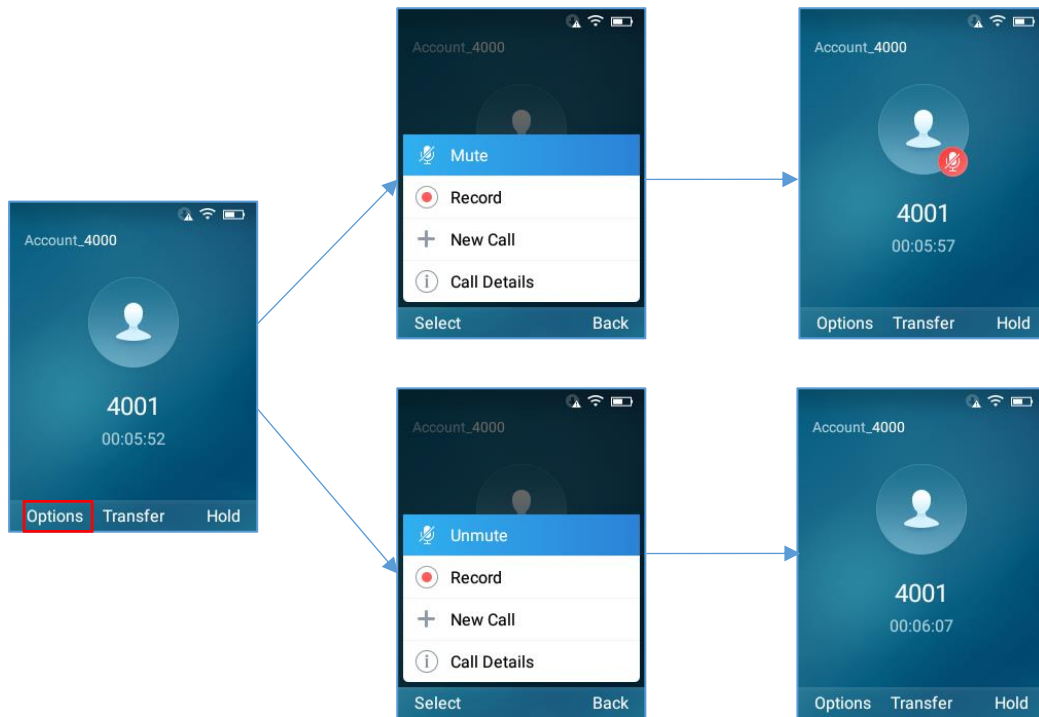

Figure 23: Muting the Microphone

Adjusting Speaker and Earpiece Volume

Press volume up and down keys on the left side of your phone while you are on an established call to set the volume of the earphone / speaker. You can choose between 8 different levels. The default level is 4.

Ringtones

Setting the Ringer Volume on the WP820

To configure the desired ringer volume, proceed as follows:

1. Press **Menu** to bring up operation menu and go to **Settings**.
2. Navigate to **Basic Settings**, and then select **Voice** tab.
3. User can configure the silent and vibrate modes and also the voice ringtones by pressing the left and right arrow keys to change repeatedly and set the desired volume.
4. Press “**Back**” (right softkey) to confirm the new configuration settings.



Notes:

- 15 levels are supported. Level 15 is the highest level. Level 8 is default.
-  appears when silent mode is enabled. In this mode no ring will be played for incoming calls.

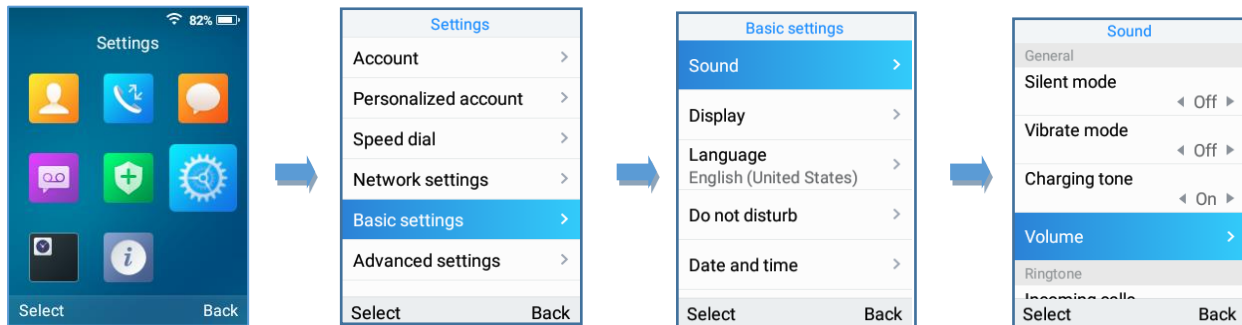

Figure 24: Ringer Volume

Setting the Ringtones on the WP820

You can change the ringer melody for an incoming call. The device has different ringer melodies and in order to configure the desired melody, proceed as follows:

1. Press **Menu** to bring up operation menu.
2. Use arrow keys to reach **Settings** → **Basic Settings**, and then select **Sound** tab.
3. Navigate to **Ringtone** section to configure ringtone for incoming calls and notification tone.
4. Press “**Select**” (left softkey) and choose the desired ringtones, press “**Save**” to confirm the ringtones selected and the new ringtones will be set successfully.

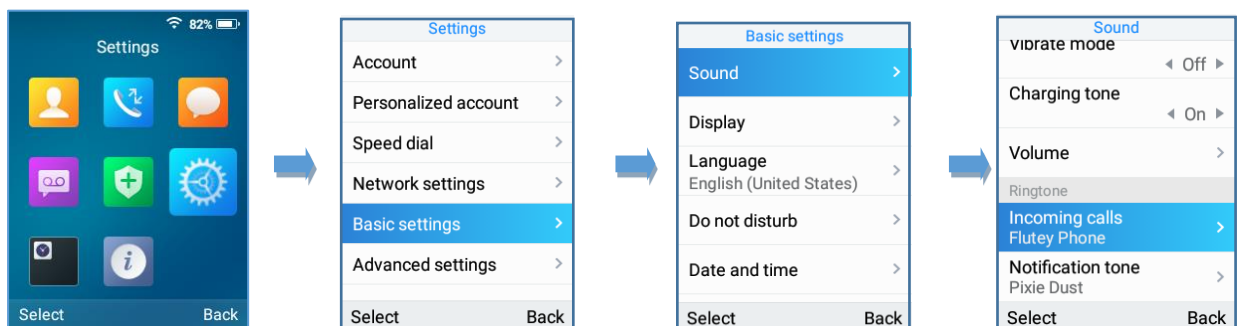

Figure 25: Calls Ringtones

Date and Time

On the WP820 the Date and time are displayed on the idle screen and it obtains the date and time from the Simple Network Time Protocol (SNTP) server by default. If your phone cannot obtain the date and time from the SNTP server, you need to configure the date and time manually. You can configure the time



format and date format respectively. The handset supports two formats for time (12 Hour or 24 Hour) and three date formats (DD/MM/YYYY; MM/DD/YYYY; YYYY/MM/DD).

To configure date and time manually

1. Press **Menu** to bring up operation menu.
2. Use arrow keys to reach **Settings** → **Basic Settings**, and then select **Date and Time** tab.
3. Press “**Back**” softkey to apply your changes.

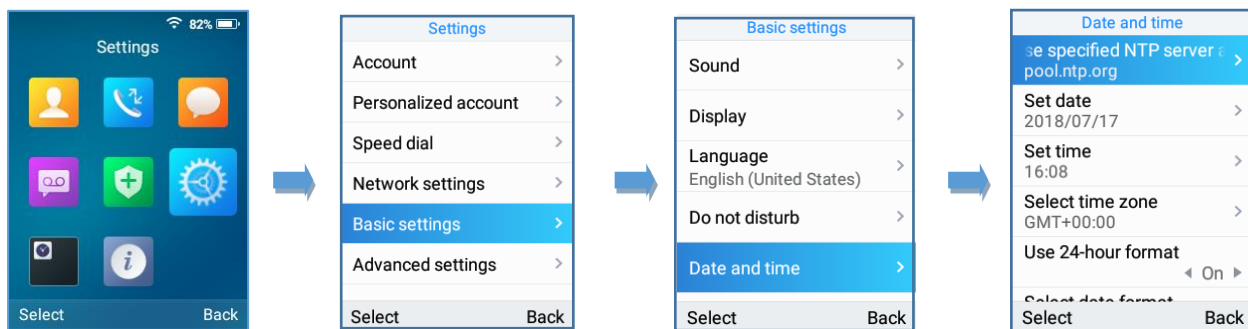

Figure 26: Date and Time Settings

Reboot the WP820

To reboot the WP820, please refer to following steps:

1. Press **Menu** to bring up operation menu.
2. Use arrow keys to reach **Settings**
3. Select **Advanced Settings**, and then navigate to **Reboot** tab.
4. A confirmation LCD message will be displayed to confirm the reboot, press “**Reboot**” button to reboot the phone or “**Cancel**” to cancel the reboot.

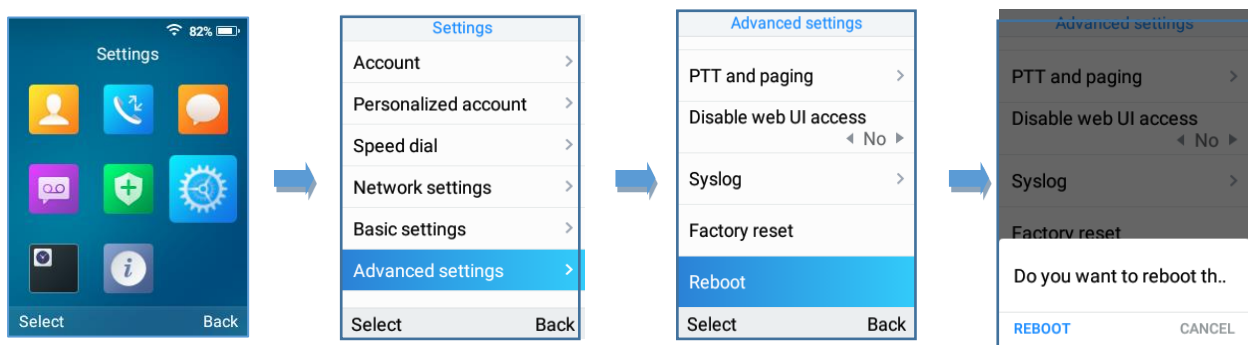

Figure 27: Reboot the WP820



CALL OPERATIONS

Placing calls

To place calls, you can use the following mode:

- **Earpiece mode:** pressing the off-hook / dial key to dial out.
- **Speakerphone mode:** pressing the speakerphone key to dial out.
- **Headset mode:** pressing the off-hook / dial key to dial out using connected headset.

During the call, you can switch the call mode by pressing the corresponding keys or connecting a headset.

Make a Call using a Line

Making calls require the use of SIP lines. So, you should first register the SIP account to the handset beforehand, after registering the sip lines, you can choose between them while trying to make calls by pressing the “**Accounts**” button displayed on the call screen.

Please refer to the following methods to make calls using a line:

Method 1:

1. Enter the desired number using the keypad.
2. Toggle between the available lines by pressing the “**Accounts**” button to choose the line for making calls. (The account name will change on the screen when press “Accounts” button).
3. Press **Dial key** , left softkey “**Call**”, # (Use # as dial key” must be configured in web configuration) to initiate the call or wait for 4 seconds and the call will be initiated automatically.



Note: Users can also initiate calls with handsfree mode using **Speaker key** .

4. To terminate the call, press **Hang-Up key** .

Method 2:

1. Press **Dial key** or **Speaker key** to enter the pre-dialing screen.
2. Toggle between available lines by pressing the “**Accounts**” button to choose the line for making calls. (The account name will change on the screen when press “Accounts” button).
3. Enter the number to dial using the keypad.



4. Press **Dial key** , left softkey “**Call**”, # (Use # as dial key” must be configured in web configuration) to initiate the call or wait for 4 seconds and the call will be initiated automatically.
5. To terminate the call, press **Hang-Up key**  .

During the call, you can switch the call mode by pressing the corresponding keys and cancel the dialing operation by pressing the on-hook key. During the call conversations, you can press the left and right navigation keys to adjust the volume. The call duration is displayed on the LCD screen while the call is in progress and call summary will be displayed once the call is terminated.

Notes:

- To dial “+” please keep pressing “0” key for about 2 seconds.
- To dial from contacts list, choose a contact using navigation keys and press **Dial key** .

Dialing from Call history

Users may use their call history entries to initiate calls. Please refer to following steps:

1. Press **Menu** to bring up operation menu.
2. Use arrow keys to reach **Call History**.
3. Select the desired entry and press **Dial key** to establish the call.

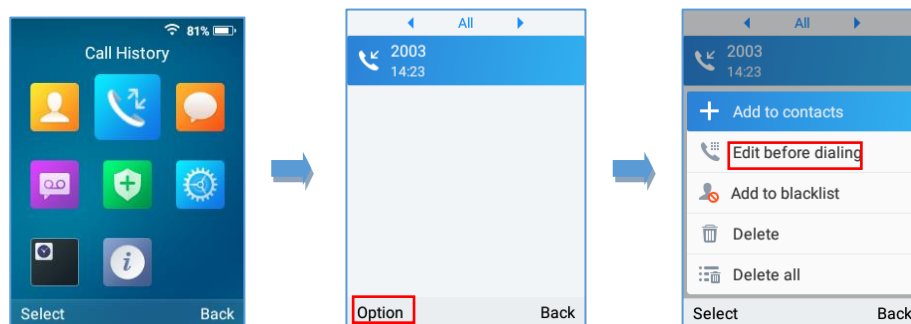



Figure 28: Dialing from Call History

Note: In step 3, users can press “**Options**” softkey followed by “**Edit before Dialing**” option to edit the number before initiating the call. The call history list stores the last dialed phone numbers. When the memory of the redial number list is full, the handset will automatically erase oldest dialed number when a new number is dialed.

Dialing from Phonebook

Users may use their contacts list to initiate calls.

1. Press **Menu** to bring up operation menu and use arrow keys to reach **Contacts** or press **Contacts**

key  to access directly the contacts list.

2. Select the contact to call and press **Dial Key** to initiate the call.

Note: In step 2, users can press “Options” softkey followed by “Edit before Dialing” option to initiate the call.

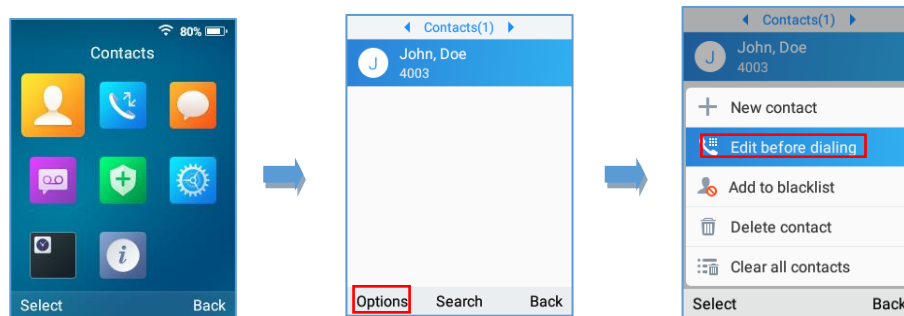

Figure 29: Dialing from Contacts List

Answering Calls

When receiving an incoming call, you can answer the call using following steps:

- **Earpiece mode:**
Press **Dial Key** to pick up the call, or “Accept” softkey (left softkey).
- **Speakerphone mode:**
Press **Speaker Key** to pick up the call.
- **Headset mode:**
Press **Dial Key** to pick up the call, or “Accept” softkey (left softkey) using a connected headset.

Note:

To answer an incoming call during an established call, press **Dial Key**, or the **Speaker Key**, or the “Answer” softkey. The incoming call is answered, and the original call is placed on hold.

Auto Answer

Users can enable Auto Answer feature to accept and automatically answer incoming calls.

If enabled, the WP820 will automatically answer incoming calls using speaker mode.



To activate / deactivate the auto answer feature:

- **Using WP820 LCD Menu**

1. Press **Menu** to bring up operation menu.
2. Use arrow keys to reach **Settings** → **Personalized Account**.
3. Select which account will be enabling the Auto answer feature and navigate to **“Auto-Answer”**.
4. Set **“Auto-Answer”** to **“On”** and configure the auto-answer mode and press **“Save”** button.

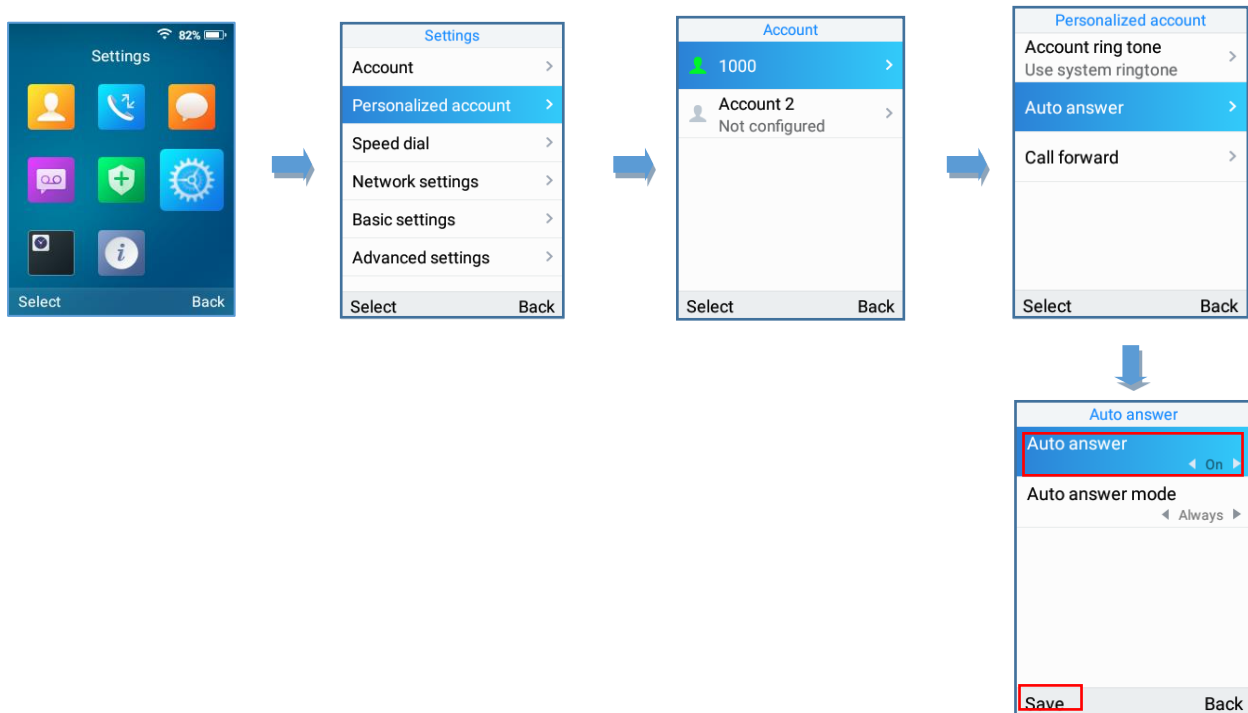

Figure 30: Auto-answer on WP820

Note: The auto-answer icon will be displayed near of the account on the LCD screen when the Auto-answer feature is enabled on the configured accounts as displayed on the following screenshot.

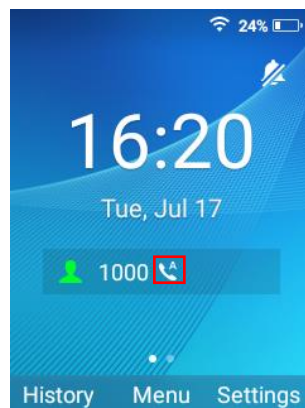



Figure 31: Auto-answer Idle Screen

- **Using WP820 Web Interface**

1. Access WP820 Web GUI Interface.
2. Navigate to Account → Call Settings → Call features.
3. Set “Auto Answer” to “Yes”. (By default, set to “No”).

Ending Calls

To terminate the calls, press **Hang-Up** key  .

Rejecting Calls

To reject an incoming call, press **Hang-Up** key  or **“Reject”** softkey (right softkey)

Call Hold/Resume

- During active call, press the right softkey **“Hold”** to put the established call on hold.
- To resume the call, press the right softkey **“Unhold”** while the established call is being on hold.

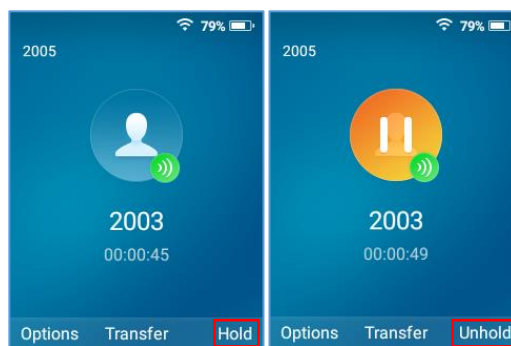

Figure 32: Hold/Unhold Calls

Notes:

- If you press **“Options”** during the established call, and then make a new call to another number, the first call will be on hold automatically.
- Users can put up to 2 calls on hold at the same time.
- The LCD screen will show the calls on hold as displayed on the following screenshot.



Figure 33: Calls on Hold

Call Waiting

This feature will notify you of a new incoming call during an established call and display the incoming call information visually on the LCD screen and a call waiting tone will be heard. If this feature is disabled, the new incoming call will be automatically rejected.

This feature is enabled from the WP820 Web GUI:

1. Access WP820 Web Interface.
2. Go to **Phone settings** → **Call Settings**.
3. Set “**Disable Call Waiting**” and “**Disable Call Waiting Tone**” to “No”.
(Default is No).
4. Press Save and Apply buttons to confirm the new settings.

Users now will be able to hear the call waiting tone and it will be visible as well on the LCD screen as displayed on the following screenshot.

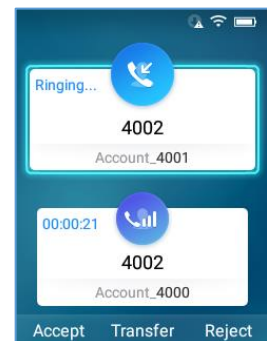

Figure 34: Call Waiting

Do Not Disturb

You can activate or deactivate the DND mode for your accounts registered on the handset from its LCD menu. If DND mode is activated, all incoming calls will receive busy treatment depending on your configuration (forward to voice mail, busy tone...).

To enable or disable the DND mode, Access LCD Menu → **Settings** → **Basic**

Settings → **Do not disturb** and set **Do not disturb** to **On**.

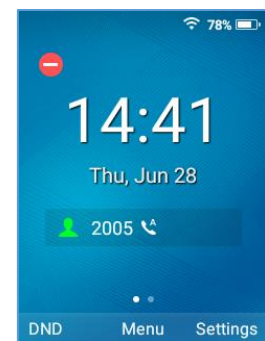

Figure 35: DND Enabled



Call Forward

The call forward feature will allow you to forward all the incoming calls to the desired number. Three possible call forward types are available on the WP820.

- **Unconditional:** All the incoming calls are immediately forwarded to the desired number.
- **Time Based:** Incoming calls are immediately forwarded to the desired number based on the configured time.
- **Others:** Incoming calls are forwarded to the desired number when Busy, when DND is enabled or when there is no response.

To enable the call forward, please refer to the following steps:

1. Press **Menu** to bring up operation menu.
2. Use arrow keys to reach **Settings** → **Personalized Account**.
3. Select which account will be enabling the call forwarding feature and navigate to **“Call forwarding”**.
4. Set **“Call Forward”** to **“On”** and select the call forwarding mode.
5. Configure the parameter of the call forward mode and press **“Save”** button.

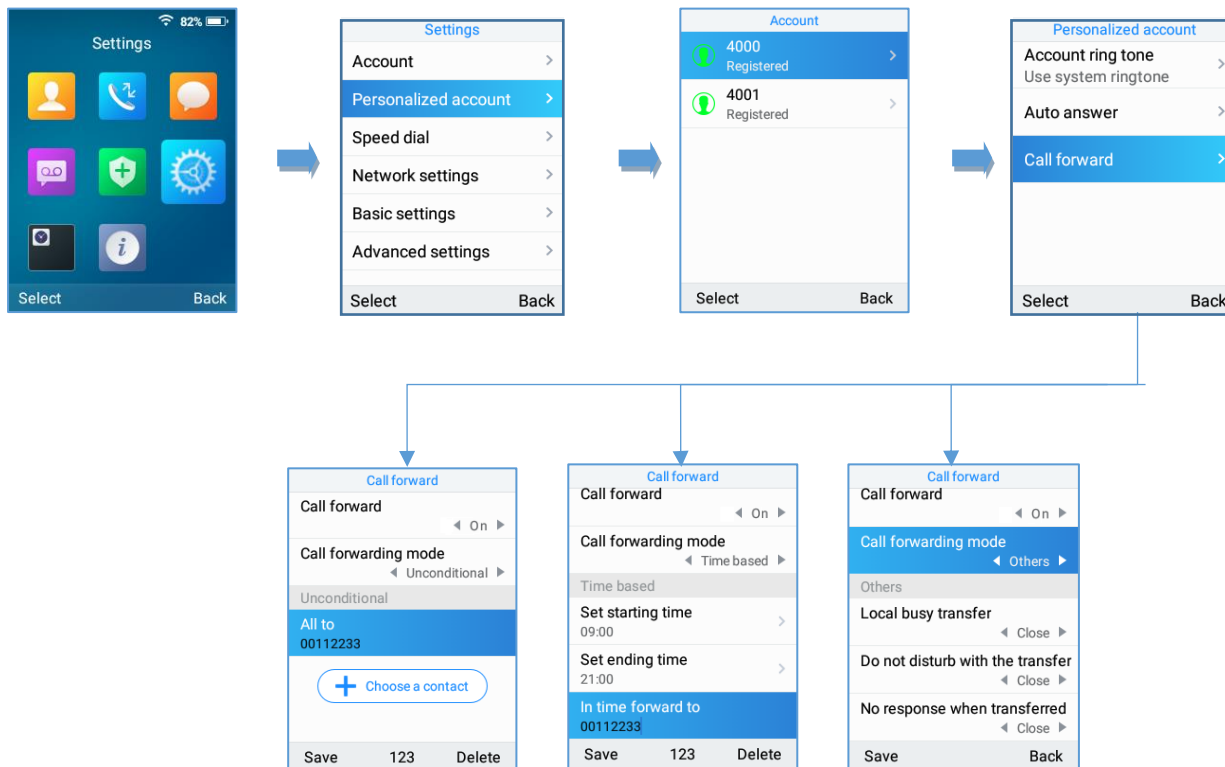

Figure 36: Call Forwarding

Note: The call forwarding can be also configured from the WP820 Web GUI → Account → Call Settings.

Call Transfer

The WP820 supports the call transfer feature, you can transfer a call to another party using one of the following ways:

- **Blind transfer:** Transfer a call directly to another party without consulting
- **Attended transfer:** Transfer a call with prior consulting.

To transfer call, please refer to the following steps:

1. Press “**Transfer**” softkey during a call, and then enter the number you want to transfer the call to.
2. Select which transfer mode you want to attend using “**Blind**” or “**Attended**” softkeys available on the LCD screen.
3. The call is connected to the number you specified, and the LCD screen prompts **Call Transferred**.

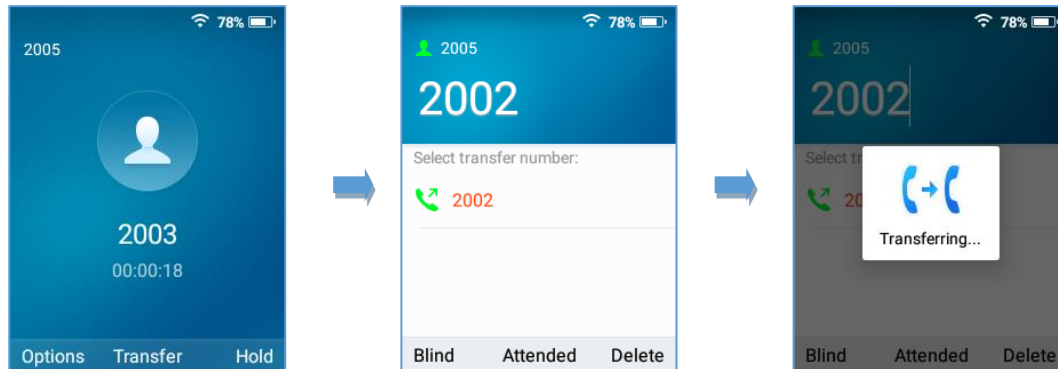

Figure 37: Call Transfer

Speed Dial

Speed dial allows users to perform single-digit dialing to predefined numbers. This feature is particularly useful to speed up dialing frequently used or hard to remember numbers. A maximum of 10 speed dial numbers is allowed. For example, the digit key 2 is configured as a speed dial key and assigned the number 4000, the phone will dial out the number 4000 directly when you long press digit key 2.

Note: The speed dial number should not be set on chosen representative number, otherwise long press will initiate a call to configured speed dial number.

To configure the speed dial (create, edit or delete) numbers, proceed as the following steps:

1. Press **Menu** to bring up operation menu and use arrow keys to reach **Settings → Speed Dial**.
2. Select the speed dial key to be configured and press “**Settings**” softkey.
3. Select the associated account and the number to be dialed.

Note: Users can also select the numbers from the contact list by selecting “Choose a contact”.



4. Press **“Save”** softkey to save the configured speed dial numbers.

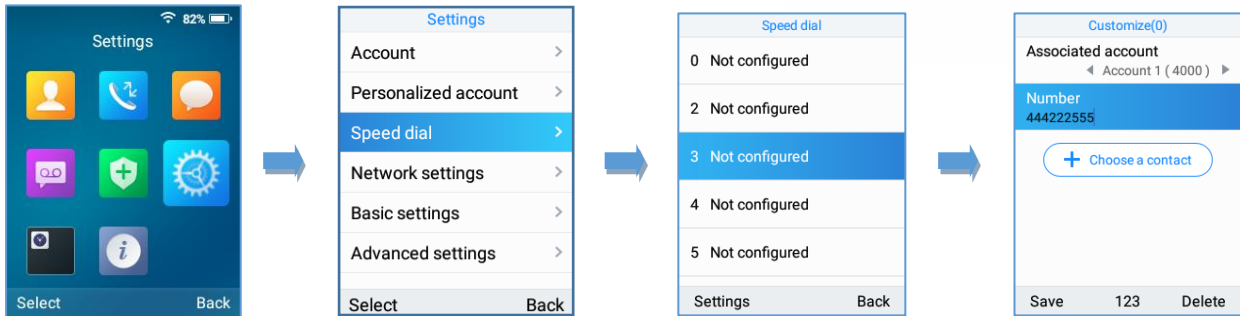

Figure 38: Speed Dial Configuration

3-Way Conference

The WP820 supports creating a local conference with other parties (including handset starting the conference). To start a 3 Way conference, follow below steps:

1. Place a call to the first party and press left softkey **“Options”**, then select **“New Call”**.
2. Enter the number of the second party you want to add to the conference and press **Dial Key**.

Note: At this stage, the first call will be on hold.

3. Once the third party answer your call, press left softkey **“Options”**, then select **“Conference”** and the conference will be established between the three parties.

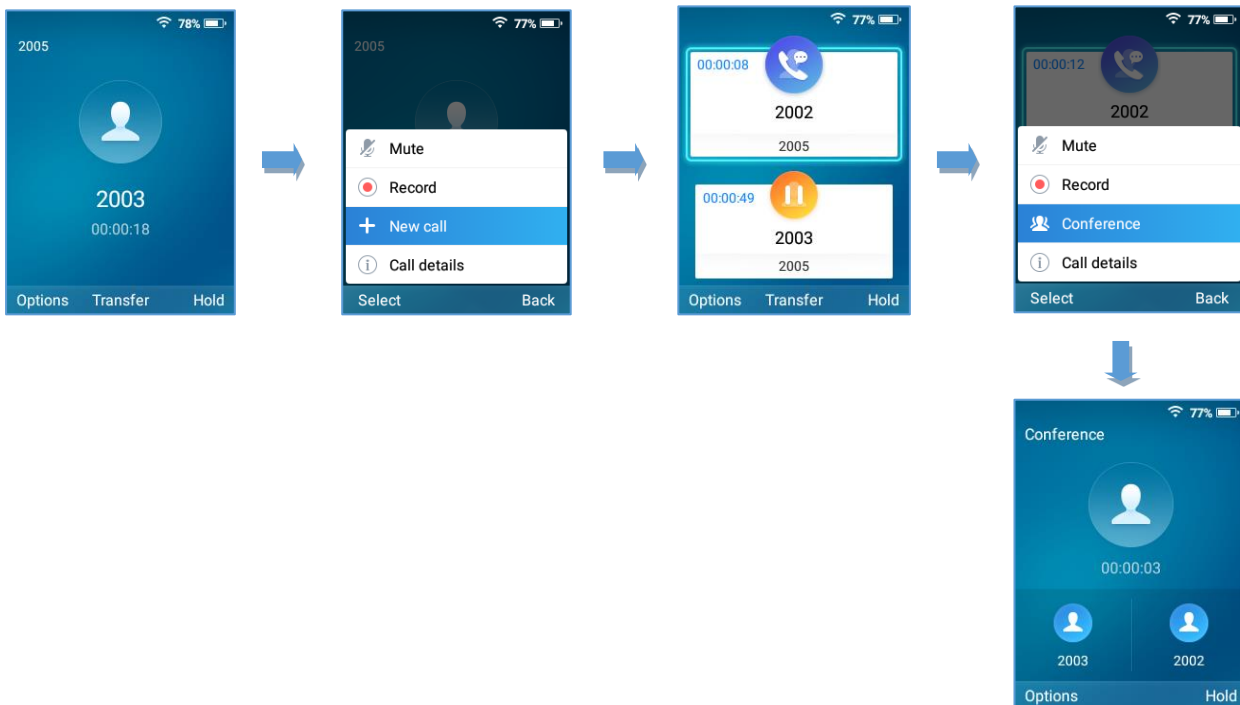

Figure 39: 3-way Conference Call



Voice Mail

The voice mail feature ensures that you will never miss any important messages. It permits either to leave voice mails to someone else or receive and listen to voice mails via the handset

Set Voice Mail ID

There are 2 ways to set Voice Mail Feature Code, either using WP820 Handset Menu or Web Interface.

Note: The Voice Mail Feature Code depends on the service provider or IP-PBX used. For example, if UCM6xxx as SIP server, the Voice Mail Feature Code is ***97**.

- **Using WP820 LCD Menu**

1. Press **Menu** to bring up operation menu.
2. Use arrow keys to reach **VoiceMail** tab.

Note: You can access the **VoiceMail** tab by long pressing on digit “1”.

3. Select the desired account and configure the **Voicemail ID** number, then press “**Save**” softkey.

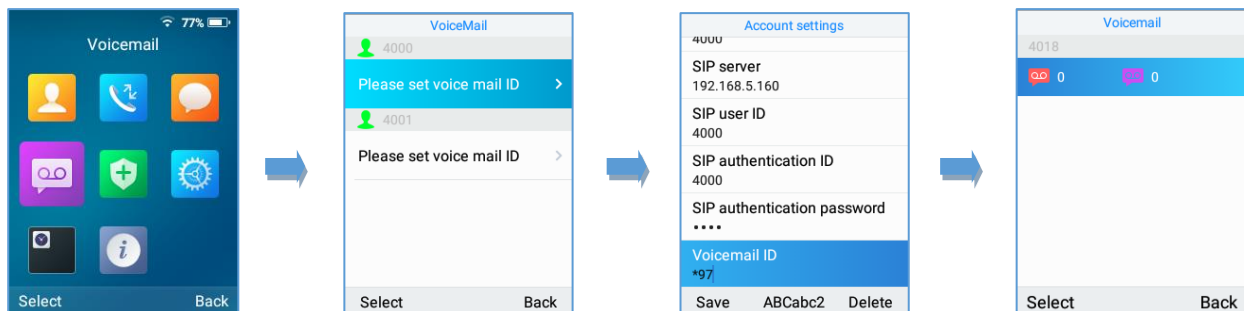

Figure 40: LCD Menu - Voice Mail ID

- **Using WP820 Web Interface**

1. Access WP820 Web GUI Interface.
2. Go to Account → General Settings → Account Registration.
3. Configure **Voice Mail Access Number**.

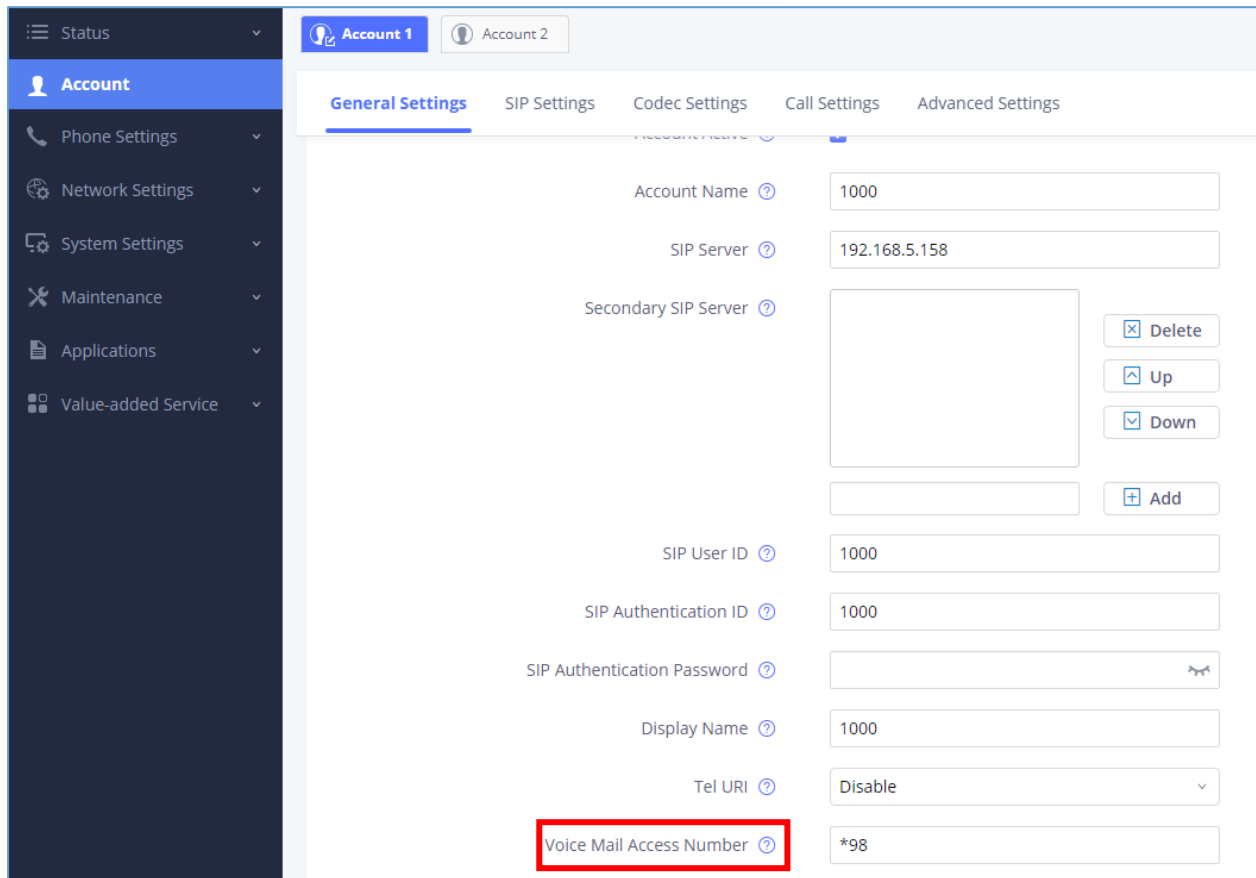

Figure 41: Web UI - Voice Mail Access Number

Play Voice Mail Messages

1. Press **Menu** to bring up operation menu.
2. Use arrow keys to reach **VoiceMail** tab.

Note: You can access the **VoiceMail** tab by long pressing on digit “1”.

3. Choose the account and press “**Select**” button to retrieve your voice messages saved on your voice mail.

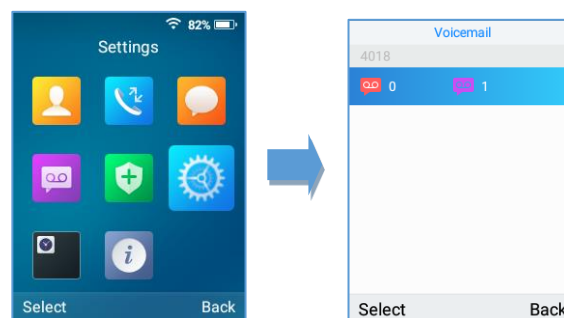

Figure 42: Playing Voicemail Messages



Notes:

- Users can access directly voicemail menu to play messages, by clicking on “Listen” (left softkey) when the notification of a new voicemail pops up on the WP820’s LCD screen.

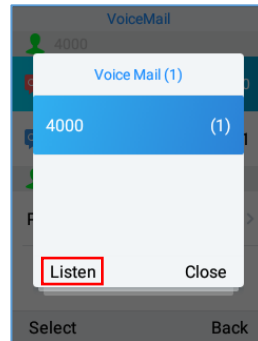

Figure 43: Voicemail Notification

- If VM is protected by a password, users can enter the password using WP820 keypad after reaching Voice Mail system. The password is defined on the service provider or IP-PBX side.

CALL FEATURES

The WP820 supports traditional and advanced telephony features including call forward and etc.

Table 10: Call Features

*72	<p>Unconditional Call Forward. To set up unconditional call forward:</p> <ul style="list-style-type: none"> • Off hook the phone; • Dial *72 and then enter the number to forward the call; • Press Call softkey or Dial key.
*73	<p>Cancel Unconditional Call Forward. To cancel the unconditional call forward:</p> <ul style="list-style-type: none"> • Off hook the phone; • Dial *73; • Press Call softkey or Dial key.
*74	<p>Paging Call. To establish a paging call:</p> <ul style="list-style-type: none"> • Off hook the phone; • Dial *74; • Press Call softkey or Dial key.
*90	<p>Busy Call Forward. To set up busy call forward:</p> <ul style="list-style-type: none"> • Off hook the phone; • Dial *90 and then enter the number to forward the call; • Press Call softkey or Dial key.
*91	<p>Cancel Busy Call Forward. To cancel the busy call forward:</p> <ul style="list-style-type: none"> • Off hook the phone; • Dial *91; • Press Call softkey or Dial key.
*92	<p>No Answer Call Forward. To set up delayed call forward:</p> <ul style="list-style-type: none"> • Off hook the phone; • Dial *92 and then enter the number to forward the call; • Press Call softkey or Dial key.
*93	<p>Cancel No Answer Call Forward. To cancel the delayed call forward:</p> <ul style="list-style-type: none"> • Off hook the phone; • Dial *93; • Press Call softkey or Dial key.



PTT (PUSH-TO-TALK) FUNCTIONALITY

The WP820 supports the Push to talk (PTT) features which is a technology based on the instantaneous communication commonly employed in wireless cellular phone services using a button to switch the device from voice transmission mode to voice reception mode. This feature is similar to "walkie talkie" use and the PTT mode switches a phone from full duplex mode, where both parties can hear each other simultaneously, to half duplex mode, where only one party can speak at one time. Multiple parties to the conversation may also be included.

Enabling PTT mode on the WP820

You can enable and configure the PTT settings using the WP820 LCD menu:

1. Press **Menu** to bring up operation menu.
2. Use arrow keys to reach **Settings** → **Advanced settings** → **PTT and paging**.
3. Choose **PTT settings** and enable the **PTT function**.
4. Press **Save** button to enable PTT mode.

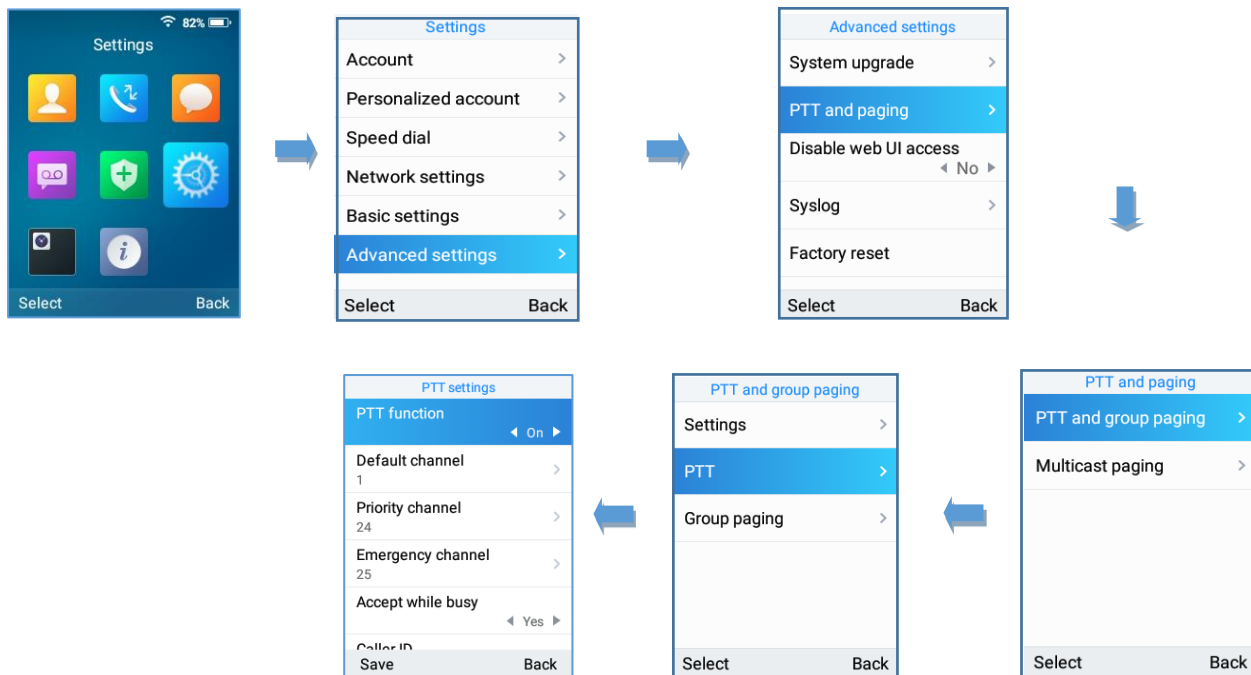

Figure 44: Enabling PTT Feature on WP820

Using the PTT Functionality on the WP820

To send a PTT broadcast from your WP820:

1. Unlock your WP820.
2. Press the Push to Talk soft key.
3. Press and hold the Push to Talk key while speaking.

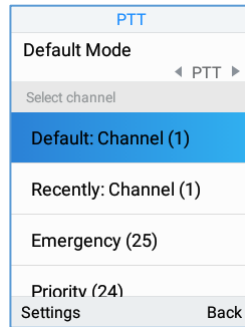

Figure 45: PPT Channel

Notes:

- Users could press and hold the Push-to-talk key from any screen to quickly initiate PTT call using default channel.
- The channel status will change to Sending PTT to indicate that you are transmitting as displayed on the following screenshot.

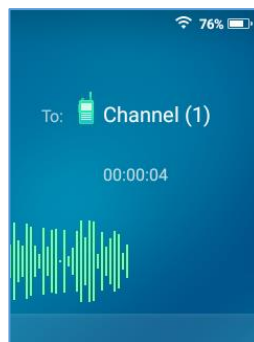

Figure 46: PTT Call (Caller)

- The devices which are in the same channel will receive the PTT call.

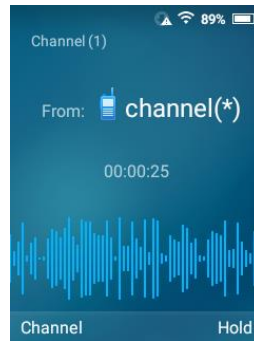

Figure 47: PTT Call (Callee)

- Release the Push to Talk soft key when you have finished speaking. The channel will wait 10 seconds before release.

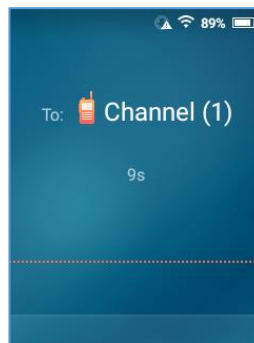

Figure 48: PTT Call Release

- You should press the Push to Talk soft key only when the channel status indicates Waiting. Otherwise, you may interrupt another person's message.

PTT Configuration Settings

Please refer to the following Settings for more details about the configuration of the PTT functionality:

Settings

- **Multicast address:** The multicast IP address to send page audio to and receive page audio from. Default value is 224.0.1.116.
- **Port:** The port to send audio to and receive audio from. Default value is 5001
- **Emergency volume:** The Volume of the emergency channel. Default value is 8

PTT Parameters

- **PTT function:** Enable or disable the PTT function.
- **Default channel:** The PTT channel used to transmit an outgoing page if the user does not explicitly specify a channel.
- **Priority channel:** The channel assigned for priority pages.
- **Emergency channel:** The channel assigned for emergency pages.
- **Accept while busy:** If no, incoming PTT sessions do not produce standard call waiting. If yes, incoming PTT sessions produce standard call waiting behavior on the active audio channel.
- **CallerID(*):** Caller ID number for identification.
- **PTime:** The audio payload size in milliseconds.
- **Audio codec:** The audio codec to use for outgoing PTT broadcasts. Incoming PTT audio will be decoded according to the codec specified in the incoming message.
- **Channel:** Set the channel whether to be usable, transported, acceptable, joined and the channel display name.

Group Paging

Enabling Group Paging Feature

You can enable and specify settings for the Group Paging feature through the phone's user interface.

To specify the Group Paging feature settings:

1. Using your phone's interface, navigate to the Group Paging Configuration menu by pressing **Settings**→ **Advanced setting**→ **PTT and paging**→**PTT and group paging**.

The Paging/PTT settings screen is displayed as below.



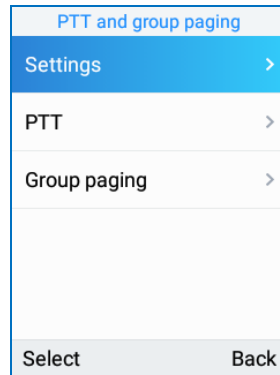

2. Choose Group Paging settings.
3. Set Paging function to Enabled.

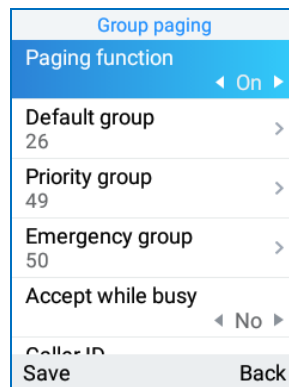

You have successfully enabled Group Paging mode.

You can also enable and specify settings for the Group Paging feature through the Web GUI by selecting **Phone Settings → PTT/Multicast Setting**.

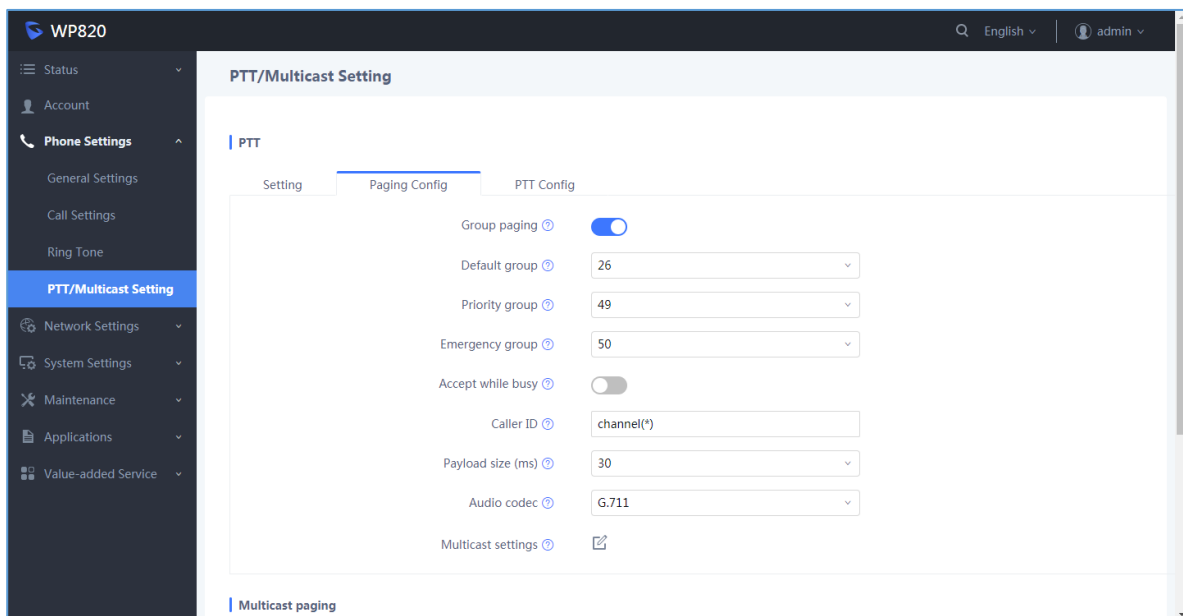
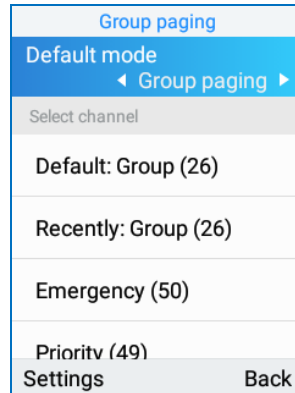

Figure 49: Enabling Group Paging

To send a Group Paging broadcast:

1. Unlock your WP820.
2. Press the Talk soft key.
3. Set Default mode to Group paging.
4. Scroll to the group you wish to send a broadcast to.



5. Press and hold the Talk soft key before speaking.

The group status will change to Sending group paging to indicate you are transmitting.

The devices which are in the group will receive the paging.

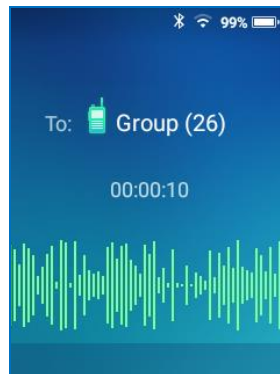

6. Release the Talk soft key, press the on-hook/power key when you have finished speaking.

Group Paging Parameters

Paging function: Enable or disable the Group paging function.

Default group: The group used to transmit an outgoing page if the user does not explicitly specify a group.

Priority group: The group assigned for priority pages.

Emergency group: The group assigned for emergency pages.



Accept while busy: If no, incoming Group paging sessions do not produce standard call waiting. If yes, incoming PTT sessions produce standard call waiting behavior on the active audio group.

CallerID(*): Caller ID number for identification.

P-Time: The audio payload size in milliseconds.

Audio codec: The audio codec to use for outgoing Group paging broadcasts. Incoming Group paging audio will be decoded according to the codec specified in the incoming message.

group: Set the group whether to be available、transmit、subscribe、join group and the group name.



WP820 INTELLIGENT CONTROL

Intelligent Control

Intelligent Control options allow to automatically answer/hang up calls upon leaving charge/connecting to charger respectively.

To configure Intelligent Control options, follow instructions below:

1. On WP820 LCD Menu Settings, select **Basic Settings** → **Accessibility** → **Intelligent Control**.
2. Set “Leave charge and answer the phone automatically” to **On**, so that phone will automatically answer the call when leaving charge.

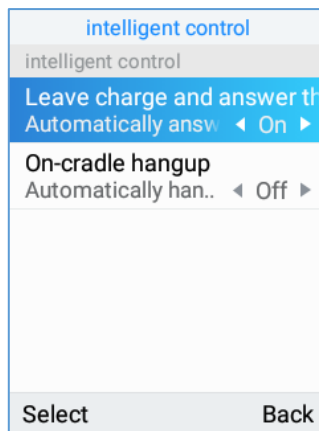

Figure 50: Intelligent Control - Auto-answer when Leaving Charge

3. Set “Charging automatically hangs up” to **On**, so that phone will automatically hang up the call when entering the charging state.

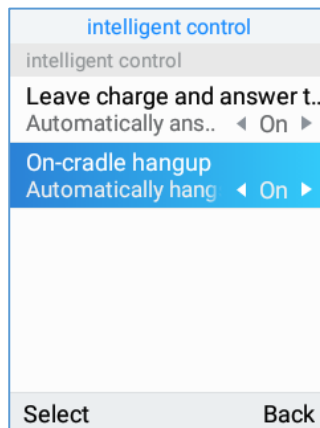

Figure 51: Intelligent Control - Auto-hang up when Entering Charging State

UPGRADING AND PROVISIONING

The WP820 can be upgraded via TFTP/HTTP/HTTPS by configuring the URL/IP Address for the TFTP/HTTP/HTTPS server and selecting a download method. Configure a valid URL for TFTP, HTTP or HTTPS; the server name can be FQDN or IP address.

Examples of valid URLs:

firmware.grandstream.com/BETA

fw.mycompany.com

Upgrade and Provisioning Configuration

There are two ways to setup upgrade and provisioning on WP820. They are Keypad Menu and Web GUI.

Configure via keypad Menu

1. In WP820 Settings, select **Advanced Settings** → **System Upgrade**.
2. Navigate to **Firmware/Config** and configure the firmware upgrade and config settings.

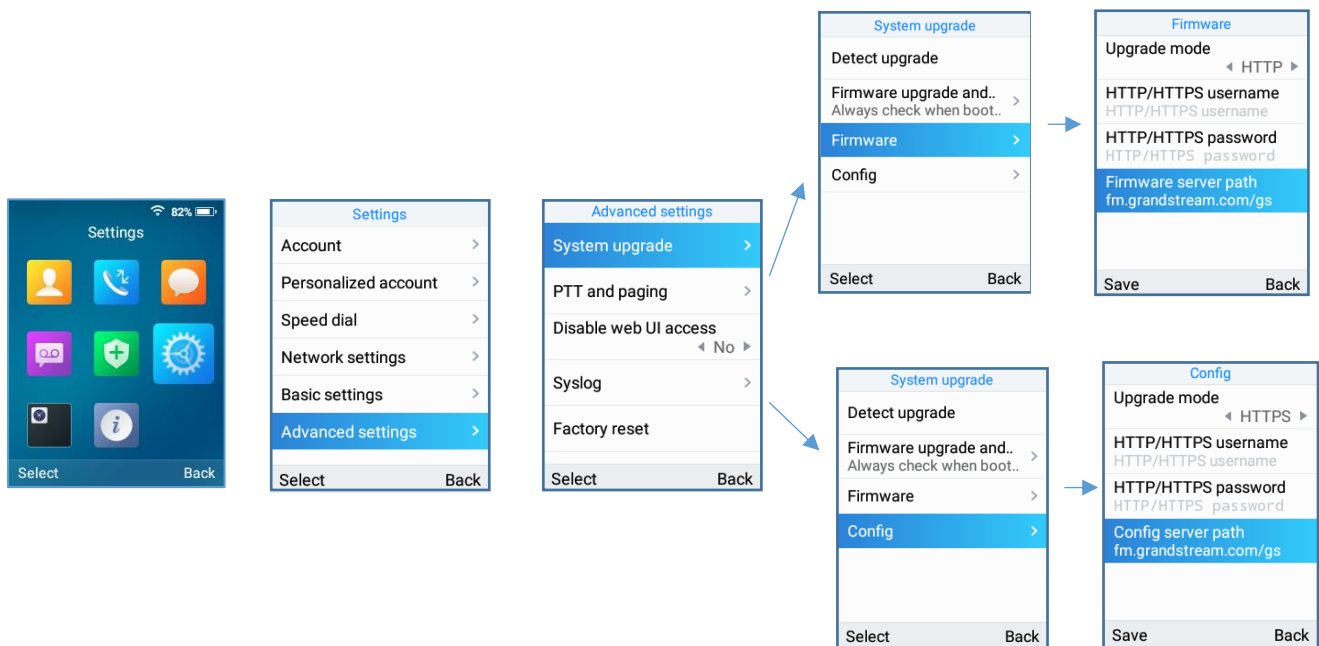

Figure 52: WP820 Upgrade Configuration via Keypad Menu

Configure via Web GUI

Open a web browser on PC and enter the IP address for the WP820. Then login with the administrator username and password. Go to **Maintenance** → **Upgrade** → **Firmware**. In the Upgrade web page, enter the IP address or the FQDN for the upgrade server and choose to upgrade via TFTP, HTTP or HTTPS (The default setting is HTTPS). Save and apply the changes, press **Upgrade** button or reboot the phone to initiate firmware upgrade process.

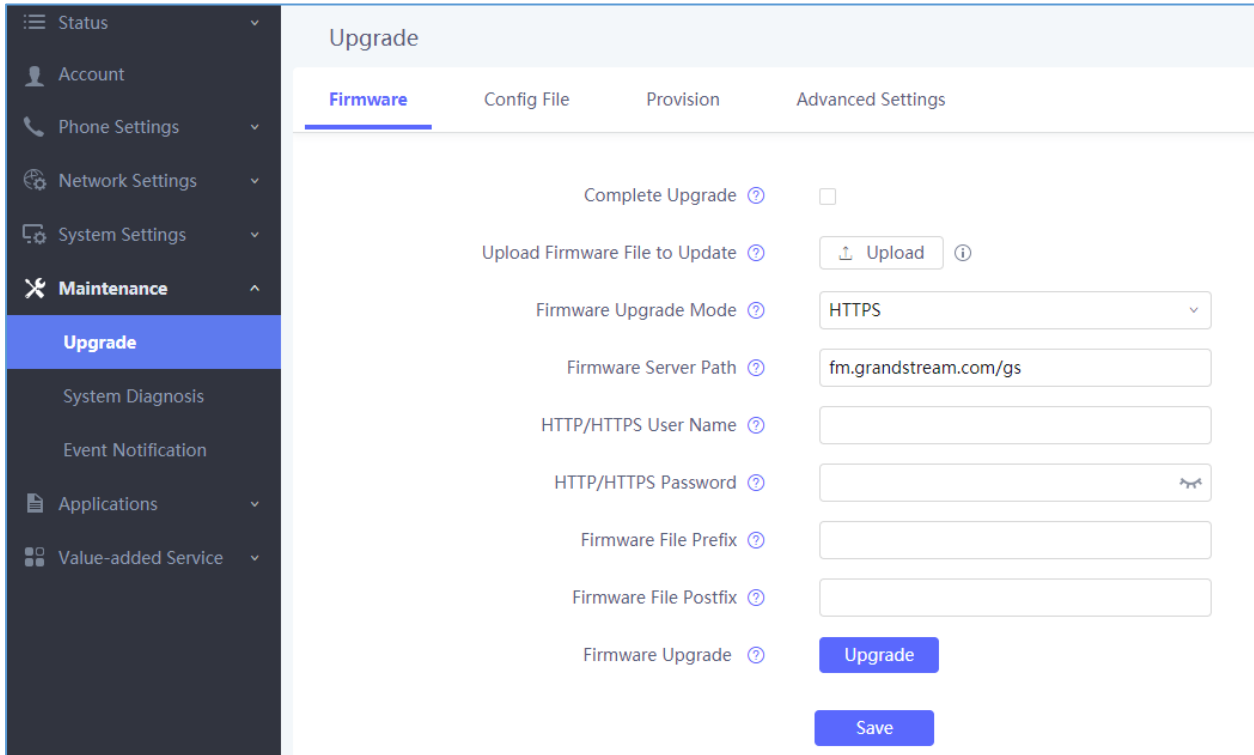

Figure 53: WP820 Upgrade Configuration via Web GUI



Note: Please do not power off or unplug the WP820 when the upgrading process is on.

Upload Firmware Locally

If there is no HTTP/TFTP server, users could also upload the firmware to the WP820 directly via Web GUI. Please follow the steps below to upload firmware to WP820 locally.

1. Download the latest WP820 firmware file from the following link and save it in your PC.

<http://www.grandstream.com/support/firmware>

2. Log in the Web GUI as administrator in the PC.
3. Go to Web GUI → **Maintenance** → **Upgrade** → **Firmware**.



4. Click the "Upload" button, a window will be prompted to select firmware file to upload.
5. Select the firmware file from your PC. Then uploading progress will show at the button where it was "Upload" in the above step.
6. When uploading is done, users can see the upgrading process starts on the WP820 LCD.
7. The phone will reboot again with the new firmware version upgraded.

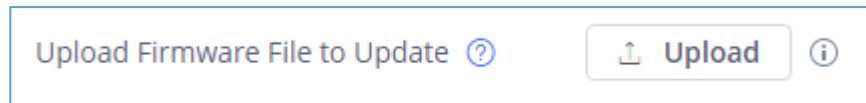

Figure 54: Upload Firmware File to Update

No Local Firmware Servers

Service providers should maintain their own firmware upgrade servers. For users who do not have a TFTP/HTTP/HTTPS server, some free Windows version TFTP servers are available for download from: <http://www.solarwinds.com/free-tools/free-tftp-server> and <http://www.tftpd64.com/>.

Please check our web site at <http://www.grandstream.com/support/firmware> for latest firmware.

Instructions for local firmware upgrade via TFTP:

1. Unzip the firmware files and put all of them in the root directory of the TFTP server;
2. Connect the PC running the TFTP server and the WP820 device to the same LAN segment;
3. Launch the TFTP server and go to the File menu→Configure→Security to change the TFTP server's default setting from "Receive Only" to "Transmit Only" for the firmware upgrade;
4. Start the TFTP server and configure the TFTP server in the phone's web configuration interface;
5. Configure the Firmware Server Path on your WP820 to the IP address of the PC;
6. Update the changes and reboot the WP820.

End users can also choose to download a free HTTP server from <http://httpd.apache.org/> or use Microsoft IIS web server.

Firmware Upgrade via USB

For users that could not use remote upgrade or could not access the phone's Web GUI to upload firmware, upgrading via external USB flash drive is an alternative. Follow the steps below to upgrade the WP820 via USB:

1. Download the firmware file to PC and save it in the USB flash drive
2. Insert the USB flash drive to the WP820.
3. Power cycle the WP820 and wait for the device to detect the firmware.



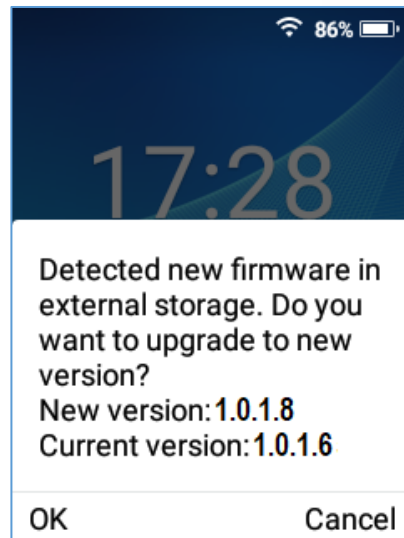

Figure 55: New Firmware Detected

4. Press OK to start the upgrade.

Note: The USB flash drive should be on **FAT32** format and the firmware file should be necessarily named **WP820fw.bin**

Provisioning and Configuration File Download

Grandstream SIP Devices can be configured via the Web Interface as well as via a Configuration File (binary or XML) through TFTP or HTTP/HTTPS. The "Config Server Path" is the TFTP, HTTP or HTTPS server path for the configuration file. It needs to be set to a valid URL, either in FQDN or IP address format. The "Config Server Path" can be the same or different from the "Firmware Server Path".

A configuration parameter is associated with each particular field in the web configuration page. A parameter consists of a Capital letter P and 1 to 5 (could be extended to more in the future) digit numeric numbers. i.e., P2 is associated with the "Admin Password" in the Web GUI → **System Settings** → **Security Settings** → **User Info Management** page. For a detailed parameter list, please refer to the corresponding firmware release configuration template in the following link:

<http://www.grandstream.com/support/tools>

When the WP820 boots up, it will issue TFTP or HTTP(S) request to download a configuration XML file named "cfgxxxxxxxxxxx" followed by "cfgxxxxxxxxxxx.xml", where "xxxxxxxxxxx" is the MAC address of the phone, i.e., "cfg000b820102ab" and "cfg000b820102ab.xml". If downloading "cfgxxxxxxxxxxx.xml" file is not successful, the provision program will download a generic cfg.xml file. The configuration file name should be in lower case letters.

For more details on XML provisioning, please refer to the following document:

http://www.grandstream.com/sites/default/files/Resources/gs_provisioning_guide.pdf



FACTORY RESET

Restore to Factory Default via LCD Menu

 **Warning:**

Restoring the Factory Default Settings will delete all configuration information on the phone. Please backup or print all the settings before you restore to the factory default settings. Grandstream is not responsible for restoring lost parameters and cannot connect your device to your VoIP service provider.

There are two methods to restore the WP820 to the factory default settings.

1. On WP820 idle screen, go to **Settings** → **Advanced Settings** → **Factory reset**.
2. In the new window, confirm the reset using the left softkey.

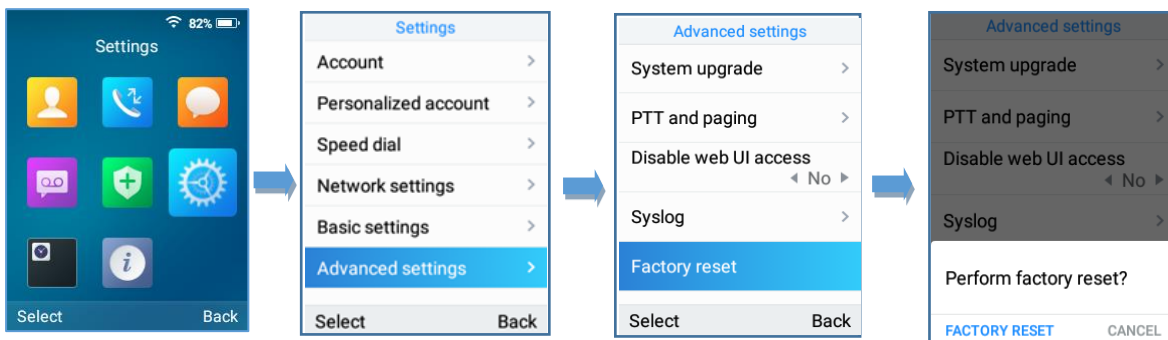

Figure 56: WP820 LCD - Confirm Factory Reset

3. Once confirming the reset the phone will reboot with the default factory settings.

Restore to Factory Default via the Web GUI

1. Login WP820 Web GUI and go to **Maintenance** → **Upgrade** → **Advanced Settings**;
2. At the bottom of the page, click on the **Reset** button for Factory reset.

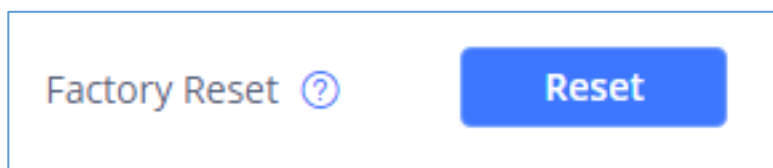

Figure 57: WP820 Web GUI - Factory Reset

3. A dialog box will pop up to confirm factory reset.
4. Click OK to restore the phone to factory settings.

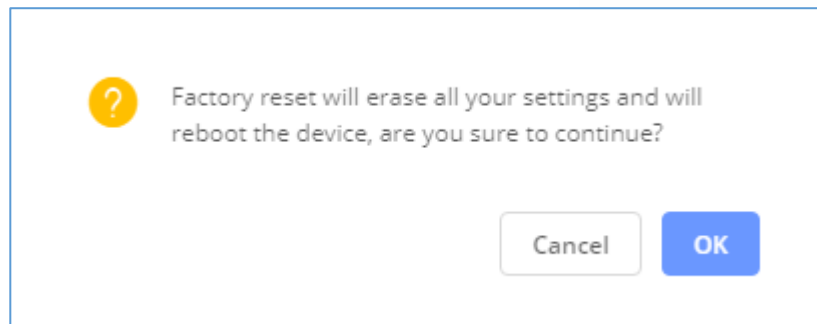

Figure 58: WP820 Web GUI - Confirm Factory Reset

Restore to Factory Default using Hard Keys

In order to perform hard reset of the phone using keypad buttons please follow below steps:

1. Power cycle the WP820.
2. Press key **1** + key **9** immediately and hold it until the LCD shows the factory reset message
3. Release the buttons and the phone will boot up with the default settings.

EXPERIENCING WP820 ENTERPRISE PORTABLE WI-FI PHONE

Please visit our website: <http://www.grandstream.com> to receive the most up- to-date updates on firmware releases, additional features, FAQs, documentation and news on new products.

We encourage you to browse our [product related documentation](#), [FAQs](#) and [User and Developer Forum](#) for answers to your general questions. If you have purchased our products through a Grandstream Certified Partner or Reseller, please contact them directly for immediate support.

Our technical support staff is trained and ready to answer all of your questions. Contact a technical support member or [submit a trouble ticket online](#) to receive in-depth support.

Thank you again for purchasing Grandstream Enterprise Portable Wi-Fi Phone, it will be sure to bring convenience and color to both your business and personal life.

